

APC9/10/40/45 PRO HA

DATA SHEET



B&T AG
3608 Thun • Switzerland
Tel +41 33 334 67 00
info@bt-ag.ch
www.bt-ag.ch

1. Technical Specifications

1.1 Overview - APC9/10/40/45



1.2 General description

The APC9/10/40/45 is a semi-automatic only pistol caliber carbine (PCC)

The working principle is recoil operation:

The recoil of a fired projectile is driving the bolt rearward. When traveling back, the bolt extracts and ejects the case of the fired cartridge, compresses the mainspring and cocks the internal hammer of the single action trigger group. At the very end of the bolt's travel, a hydraulic recoil buffer is stopping it gently and the compressed mainspring drives the bolt back against the barrel. While traveling forward, the bolt feeds a new cartridge out of the magazine into the chamber of the barrel. After completion of such a cycle, the weapon is loaded and armed.

The next shot is released by pulling the trigger.

The weapon has mechanical flip up sights, an additional reflex sight can be mounted on the accessory rail. The reflex sight can be included in the scope of delivery, depending on the version of the weapon.

Controls such as bolt catch, magazine catch, fire selector and charging handle are designed ambidextrous

1.3 General Technical data

Designation	APC_PRO HA
Manufacturer	B&T AG - Switzerland
Operating system	Recoil operated, closed bolt blowback action
Sights	Flip-up iron sight with two aperture holes
Bore height	72 mm / 2.87 in
Rail height	38 mm / 1.49 in
Interfaces	2 NATO Accessory rails
Scope of delivery	Weapon with magazines, carrying sling, cleaning kit, case

Stock Options	Stock length			Stock width		Weight difference to Standard
	retracted	extracted	folded / retracted	folded out / retracted	folded / retracted	
	[mm] / [in]					
Folding stock (standard)	240 / 9.44	n.v.	30 / 1.18	62 / 2.44	102 / 4.01	0 (410) / (0.9)
Teleskopic stock**	n.v.	232 / 9.13	53 / 2.08	54 / 2.12	n.v.	+147 / +0.32
Fold- retractable stock**	202 / 7.95	242 / 9.52	31 / 1.22	62 / 2.44	103 / 4.05	+253 / +0.55
Fold- retract. stock PRO**	193 / 7.59	270 / 10.6	30 / 1.18	52 / 2.04	84 / 3.3	+100 / +0.22
Fixed stock	247 / 9.72	n.v.	n.v.	62 / 2.44	n.v.	+90 / +0.19
Folding stock Skeleton	230 / 9.05	n.v.	36 / 1.41	38 / 1.49	53 / 2.08	-90 / -0.19
Helmet stock**	218 / 8.58	293 / 11.5	31 / 1.22	62 / 2.44	103 / 4.05	-20 / -0.04
M4-Adapter foldable***	59 / 2.32	n.v.	30 / 1.18	62 / 2.44	102 / 4.01	-150 / -0.33
NAR-Adapter	18 / 0.7	n.v.	n.v.	38 / 1.49	n.v.	-230 / -0.5
M4-Adapter***	30 / 1.18	n.v.	n.v.	62 / 2.44	n.v.	-150 / -0.33

Extracted to the maximum, intermediate positions existent / * Without M4 stock.

Technical data are provided for information only and shall not serve as acceptance criteria.

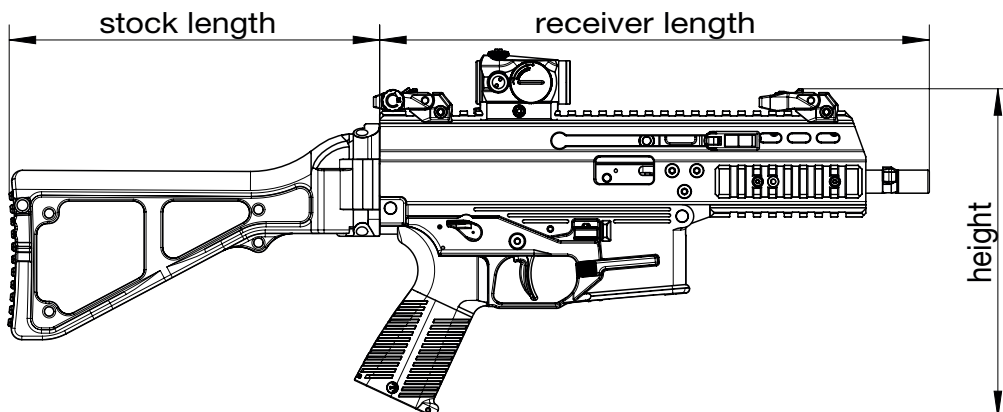

The overall length is determined by adding the receiver length and the stock length.

1.3.1 Technical data - APC9 PRO HA

Designation	APC9 PRO HA
Product ID	BT-36043
Caliber	9x19 mm
Magazine capacity	15/30 round
Rifling	6 Grooves, right hand twist

Typ		Standard	Short «K»	Long «K»	SD US	Silenced «SD»
Barrel length	[mm] / [in]	175	138	240	146	146
Length standard	[mm] / [in]	597	373	662	442	767
Length receiver	[mm] / [in]	357	320	422	412	526
Width	[mm] / [in]	62	57	62	62	62
Height*	[mm] / [in]	215	215	215	215	215
Weight	[kg] / [lbs]	2.7	2.78	2.89	2.33	3.17

* Without magazine, flip-up sights folded.

1.3.2 Technical data - APC10 PRO G HA

Designation	APC10 PRO G HA
Product ID	BT-36049
Caliber	10 mm AUTO
Magazine capacity	15 round
Rifling	6 Grooves, right hand twist

Barrel length	[mm] / [in]	175
Length standard	[mm] / [in]	612.5
Length receiver	[mm] / [in]	372
Width	[mm] / [in]	60
Height*	[mm] / [in]	215
Weight	[kg] / [lbs]	2.68

* Without magazine, flip-up sights folded.

1.3.3 Technical data - APC40 PRO G HA

Designation	APC40 PRO G HA
Product ID	BT-36026
Caliber	.40 S&W
Magazine capacity	22 round
Rifling	6 Grooves, right hand twist

Barrel length	[mm] / [in]	146
Length standard	[mm] / [in]	597
Length receiver	[mm] / [in]	357
Width	[mm] / [in]	62
Height*	[mm] / [in]	215
Weight	[kg] / [lbs]	3.18

* Without magazine, flip-up sights folded.

1.3.4 Technical data - APC45 PRO HA

Designation	APC45 PRO HA
Product ID	BT-361356
Caliber	.45 ACP
Magazine capacity	15/30 round
Rifling	6 Grooves, right or left hand twist

Barrel length	[mm] / [in]	175
Length standard	[mm] / [in]	597
Length receiver	[mm] / [in]	357
Width	[mm] / [in]	62
Height*	[mm] / [in]	215
Weight	[kg] / [lbs]	2.42

* Without magazine, flip-up sights folded.

1.4 Variant overview

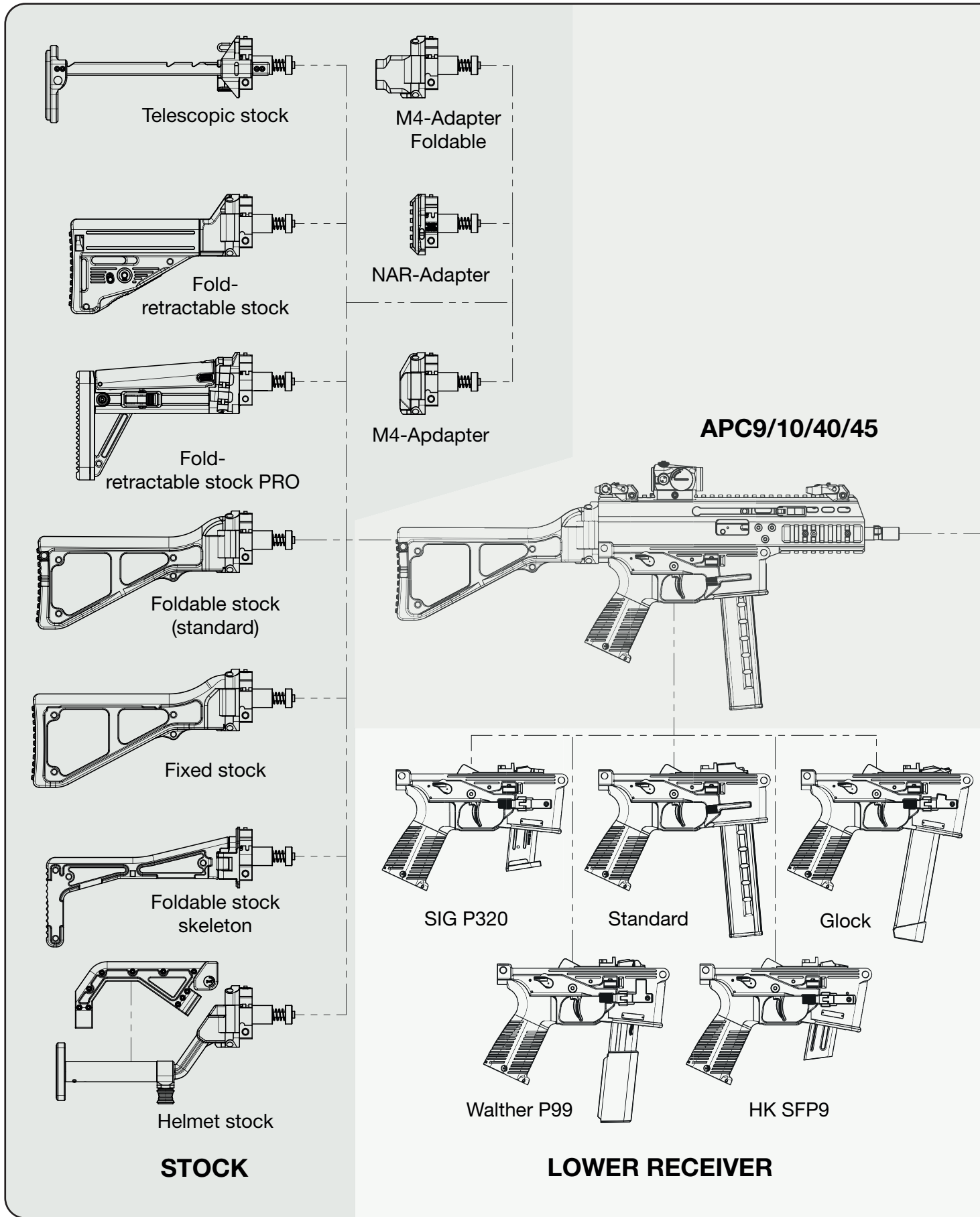

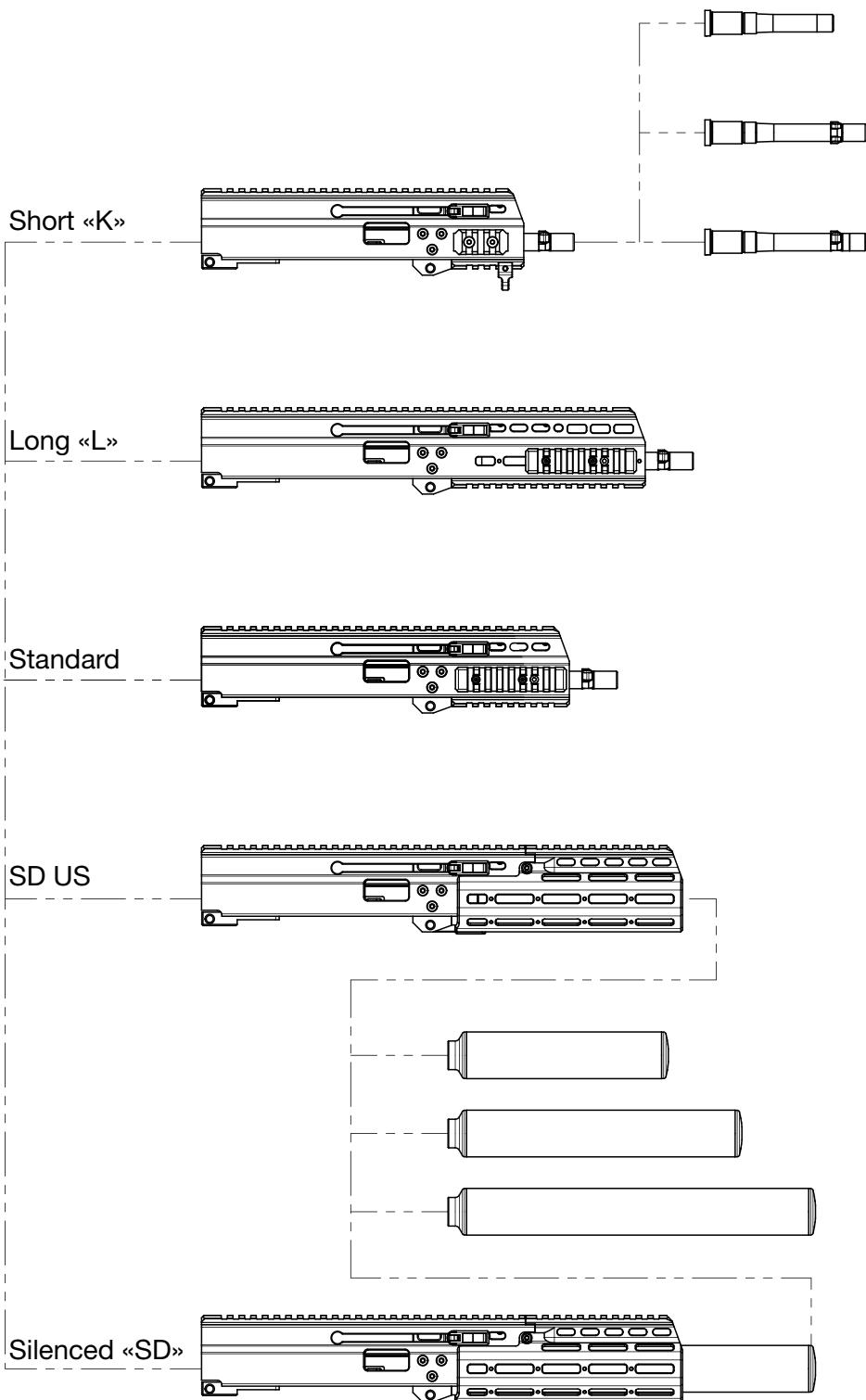

UPPER RECEIVER

2. Accessories
2.1 Stocks / Adapters

Picture	Art.-No.	Type	Description
	SD-988206 SD-123422 SD-123427	APC9 APC40 APC45	Suppressor SQD™
	SD-988100 SD-988165	APC9 APC45	Suppressor QD™
	SD-988100-C	APC9	Suppressor Compact QD™
	SD-123020	APC9	Suppressor RBS-9 QD
	SD-123021	APC9	Suppressor RBS-9 Compact QD

Picture	Art.-No.	Type	Description
	SD-123377	APC9	Suppressor RBS SQD™
	SD-123378	APC9	Suppressor RBS SQD™ Compact

2.2 Stocks / Adapters

Picture	Art.-No.	Type	Description
	BT-361639 BT-361643	APC9/40/45 APC10	Fold- retractable stock PRO
	BT-20394 BT-200579	APC9/40/45 APC10	Telescopic Stock
	BT-361412	APC9/40/45	Helmet stock
	BT-361114	APC9/40/45	Foldable stock (skeleton)
	BT-361413	APC9/40/45	Fix stock

Picture	Art.-No.	Type	Description
	BT-361410 BT-361425	APC9/40/45 APC10	Foldable stock (standard)
	BT-361415	APC9/40/45	M4 Adapter Foldable
	BT-361414 BT-361424	APC9/40/45 APC10	M4 Adapter
	BT-361555	APC9/40/45	NAR-Adapter

2.3 Magazines

Picture	Art.-No.	Type	Description
	BT-30183 BT-30298 BT-30296 BT-30209	APC9	Magazine 30 rounds Magazine 25 rounds Magazine 20 rounds Magazine 15 rounds
	BT-30531 BT-30376 BT-30528	APC45	Magazine 25 rounds Magazine 17 rounds Magazine 12 rounds
	GL-4429	APC9 APC10 APC40 APC45	Magazine 33 rounds
	BT-231229 BT-30436	APC9 APC45	Magazine loader
	BT-300696	APC9	B&T bumper pad for magazine PRO
	BT-300698	APC9	B&T magazine upgrade kit with rubber bumper for old B&T magazines

Picture	Art.-No.	Type	Description
	BT-22379 BT-22380	APC9 APC45	Magazine clamp

2.4 Lamps

Picture	Art.-No.	Description
	BT-WML-B-W-L-GEN2	WML GEN-2 Weapon mounted light

2.5 Brass catch

Picture	Art.-No.	Description
	BT-22362	Brasscatcher



2.6 Flash hider

Picture	Art.-No.	Description
	BT-400983	Flashhider Vortex QD

2.7 Grips

Picture	Art.-No.	Description
	BT-231227-BK	Angled fore grip 45° picatinny rail attachment
	BT-211564-BL	Unigrip QD short
	BT-21840	Unigrip QD

2.8 Sights

Picture	Art.-No.	Designation
	AP-11830-BT-QD	Aimpoint® sight Micro T-1 black - NVD compatible, 4 MOA, ACET technology - with B&T QD NAR mount
	AP-200709	Aimpoint® sight Micro T-1 black - NVD compatible, 2 MOA, ACET technology - with 39 mm spacer mounted (bulk packed)

2.9 Maintenance

Picture	Art.-No.	Type	Description
	SC-99B/6		Cleaning rod extension
	SC-TR/P_9_M5 SC-TR/P_45_M5	APC9 APC45	Cleaning kit

All rights reserved. Data is provided for the purpose of product description only, and must not be construed as warranted characteristics in the legal sense. The information does not relieve users from the duty of conducting their own evaluations and tests. Because the products are subject to continual improvement, we reserve the right to amend the product specifications contained in this data sheet.