

RBS QDM Kal. 5.56/.223

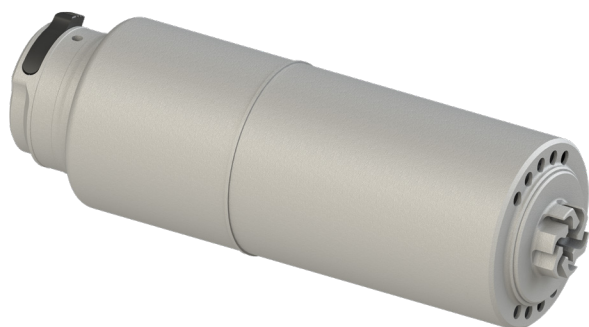

Further information

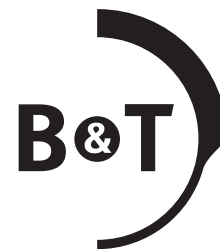

- Kal. 5.56/.223
- Quick release mount Compatible with M.A.R.S. flashhider
- 23dB A noise reduction

Technical Data

Description	RBS QDM 5.56/.223
Manufacturer	B&T AG - Switzerland
Article-No.	SD-122963
Interface	Quick release M.A.R.S. flashhider
Calibre	5.56x45/.223 Remington
Length	162 mm
Length past barrel	96 mm
Tube Diameter	52 mm
Weight	~464 g
Material	Steel, Stainless steel
Colour	Black/Grey - Cerakote coating on request
Surface treatment	Teniferiert QPQ treatment, sandblasted
Sound reduction	~ 23dB A
Increase in rate of fire	~ 6%
Service Life	min. 5.000 rounds
Full auto capable	Yes
Ambient temperature for use	-45°C...70°C

Dimensions

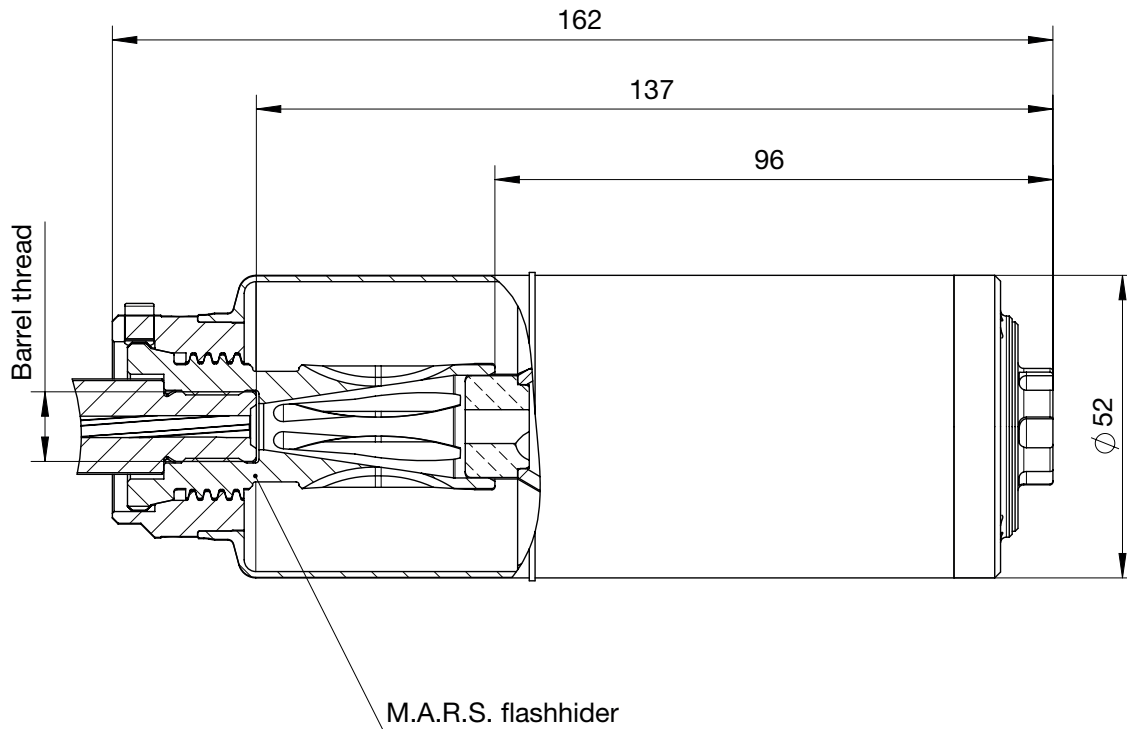

Accessories

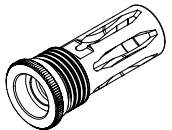
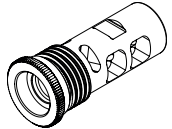
Description	Caliber	Thread	Article-No.	Picture
Flashhider M.A.R.S.	5.56mm/.223 Rem.	1/2"-28 UNEF	SD-122371	
		M15x1	SD-122420	
Compensator M.A.R.S.	5.56mm/.223 Rem.	1/2"-28 UNEF	SD-122595	

Different Threads available on request.

All rights reserved. Data is provided for the purpose of product description only, and must not be construed as warranted characteristics in the legal sense. The information does not relieve users from the duty of conducting their own evaluations and tests. Because the products are subject to continual improvement, we reserve the right to amend the product specifications contained in this data sheet.