

## Rotex-IIA® SureFire® Kal. 5.56/.223

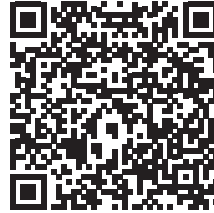

Further information

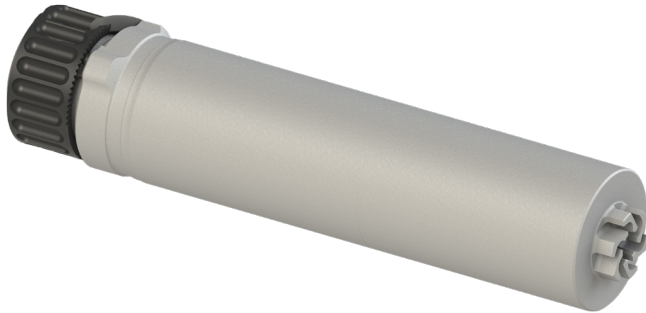
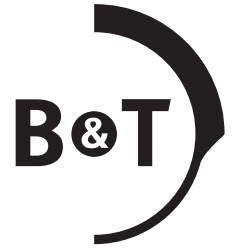

- Quick release mount compatible with SureFire® Muzzle devices
- 33dB A noise reduction
- Thermax/Inconel baffles

### Technical Data

Description	Rotex-IIA® Kal. 5.56/.223 SureFire®
Manufacturer	B&T AG - Switzerland
Article-No.	SD-123604
Interface	Quick release SureFire® Muzzle devices
Calibre	5.56x45/.223 Remington
Length	182 mm
Length past barrel	115 mm
Tube Diameter	39 mm
Weight	~465 g
Material	Steel, Stainless steel
Colour	Black/Grey - Cerakote coating on request
Surface treatment	Teniferiert QPQ treatment, sandblasted
Sound reduction	~ 33dB A
Service Life	min. 5.000 rounds
Full auto capable	Yes
Ambient temperature for use	-45°C...70°C

## Dimensions

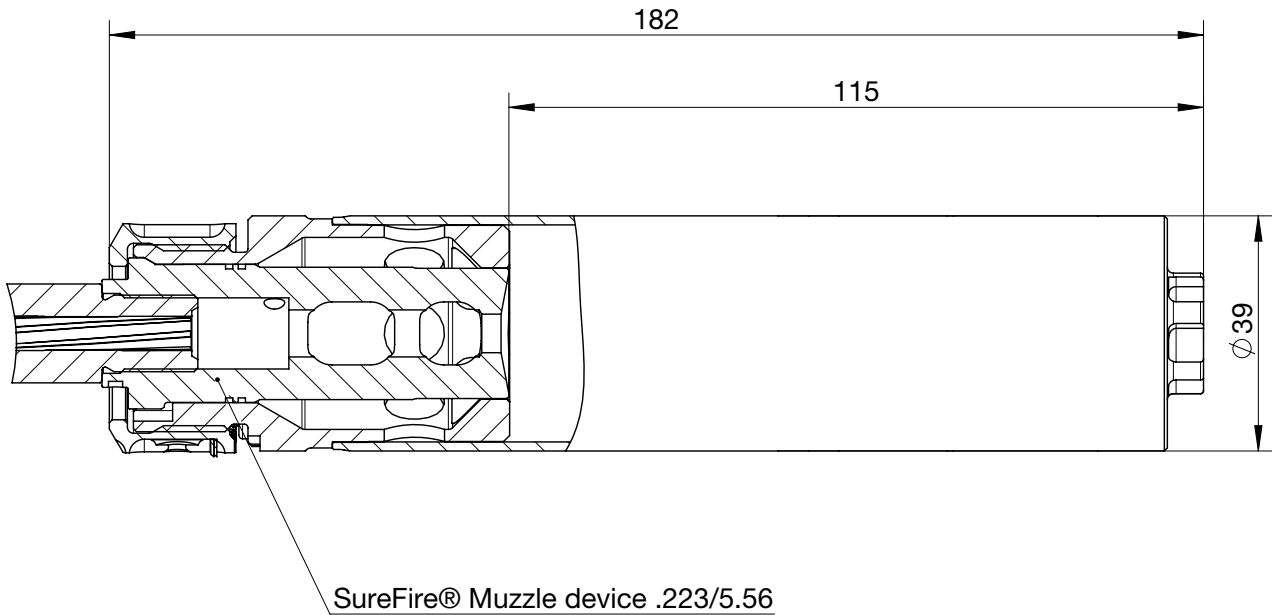

## Compatible SureFire® muzzle devices

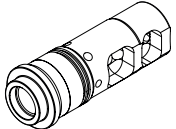
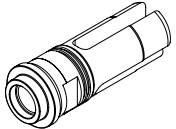
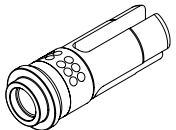
Description	Type	Picture
Muzzle brake	SFMB-556	
Flash hider	SF3P-556	
Warcomp	Warcomp-556	

All rights reserved. Data is provided for the purpose of product description only, and must not be construed as warranted characteristics in the legal sense. The information does not relieve users from the duty of conducting their own evaluations and tests. Because the products are subject to continual improvement, we reserve the right to amend the product specifications contained in this data sheet.