

Quality. Precision. Innovation.

SUPPRESSORS

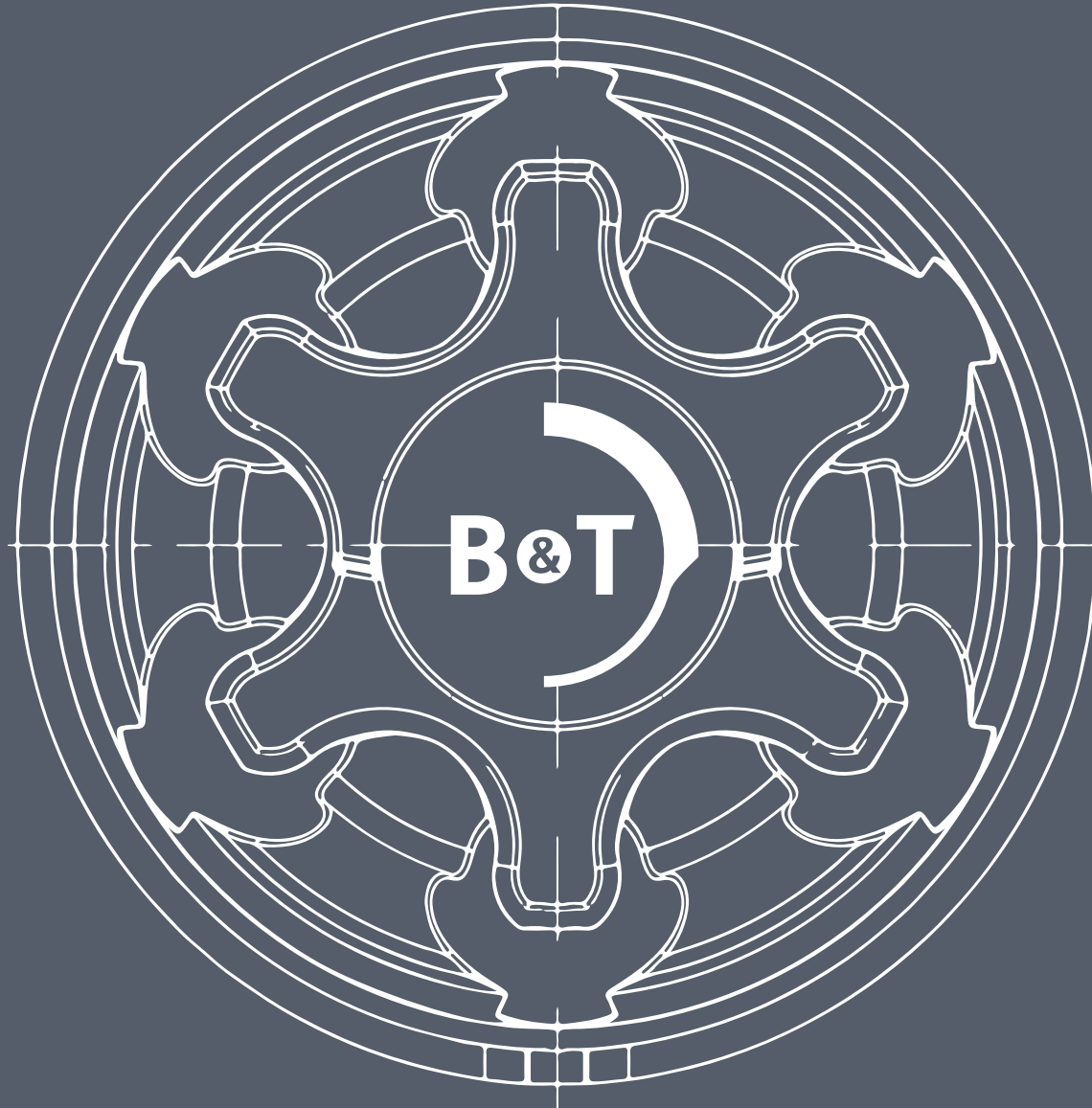

CATALOGUE 24

B&T: SWISS MADE QUALITY, PRECISION AND INNOVATION.

Over the past 30 years, a small company on the shores of Lake Thun, known to only business insiders, has grown into a small force in the industry. Despite growth and change, B&T has kept the most important thing with that it started more than thirty years ago.

That is, passion for firearms and creating high-precision solutions for the most demanding customers. B&T AG, a Swiss company with an excellent reputation as a specialist producer of carbines, sub-machine guns, suppressors and weapon accessories. B&T stands for quality, precision and innovation worldwide.

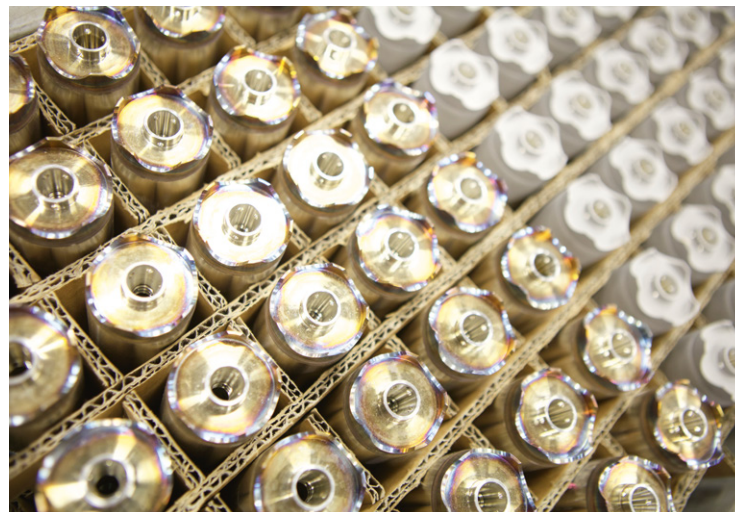



06 HISTORY

08 SUPPRESSOR BASICS

10 PISTOL / SMG SUPPRESSORS

16 SERVICE RIFLE / MACHINE GUN SUPPRESSORS

INTERFACES, ROTEX, MARS, RBS, MG, DUMMIES

30 CUSTOM SOLUTIONS

38 HUNTING / PRECISION RIFLE SUPPRESSORS

42 CONTACT

HISTORY

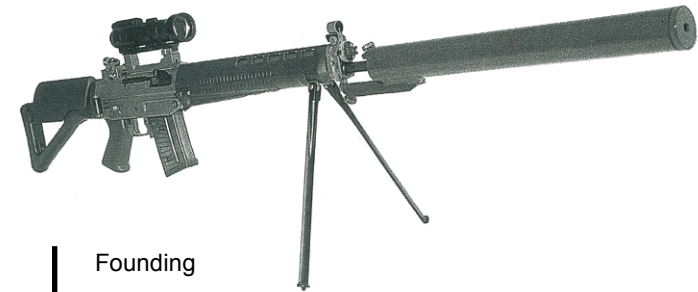

Founding

1992

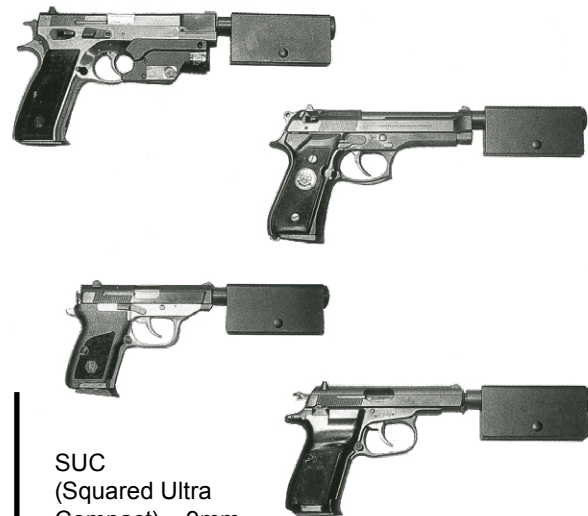

SUC
(Squared Ultra
Compact) – 9mm
Pistol Suppressor

1997



Rotex III
– Excellent Suppression.

2009



M.A.R.S.
(Miniature Assault Rifle Suppressor)
– A new lightweight and
accurate interface

2019

1991

QD SMG/PDW
– With minor changes
still in use today!

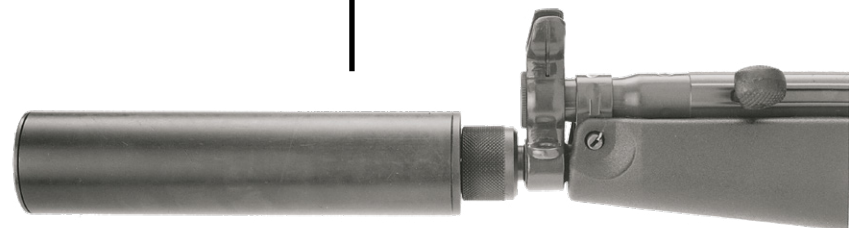

1996

Impuls IIA
– Used by Police and
Militaries to this day.

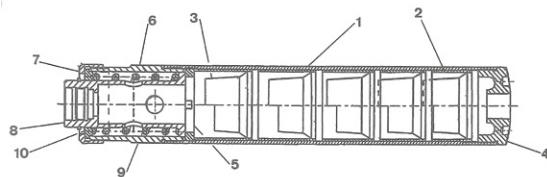

2004

Rotex V
– The Standard for ARs
with NATO flash hiders.



2017

RBS
(Reduced Back Pressure Suppressor)
– To reduce gas blowback – to protect
weapon and shooter.



SUPPRESSOR BASICS

Firearm suppressors have been around for well over 100 years. However, these have become widely popular only over the last 20 years. During this time the requirements have changed in many ways.

While suppressors were initially obscure tools for selected special applications, today these items are the primary instruments for hearing protection and signature reduction. In order to make the actual effects of suppressors clear, some basic principles should be explained.

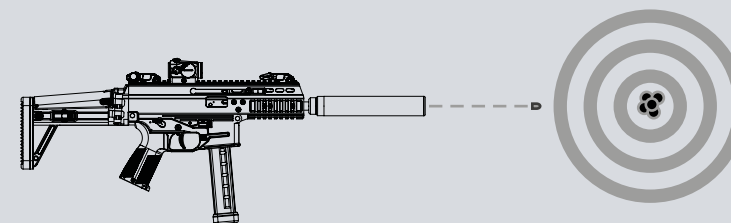
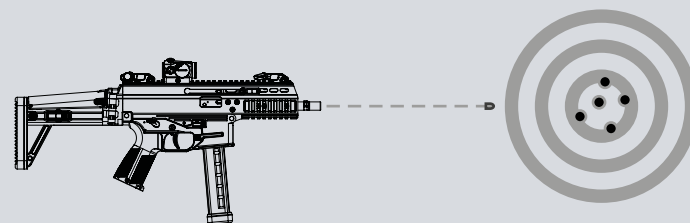
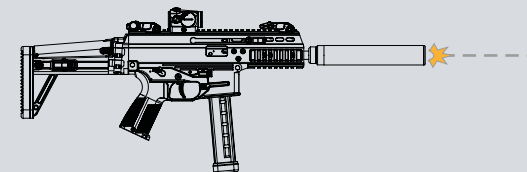
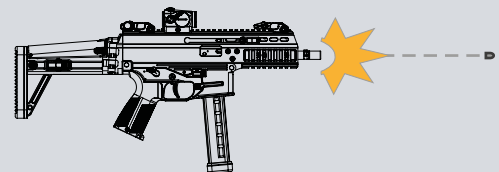
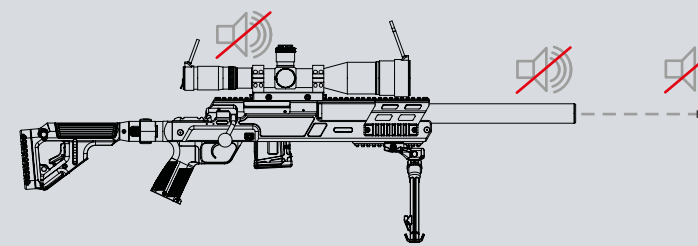
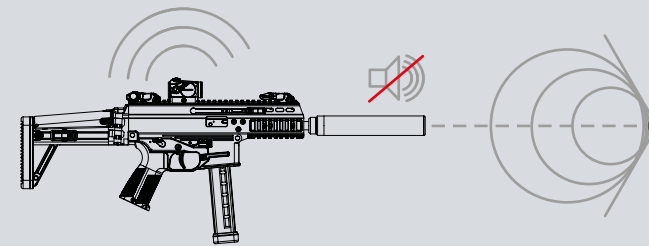
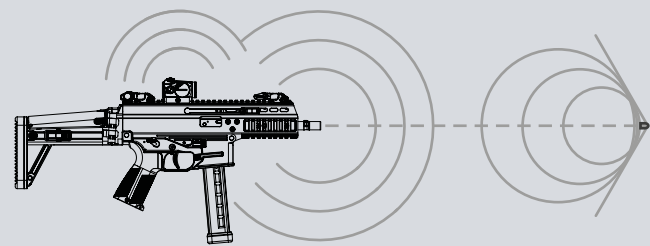

When a bullet leaves the barrel of a firearm, the gas pressure, equaling several hundreds to thousands of times atmospheric pressure, is suddenly equalized. This process is perceived by the human ear as a loud bang. To reduce it, suppressors restrict and slow the flow of the combustion gases at the muzzle. Another source of sound when a shot is fired is the sound of the bullet moving above the speed of sound. The final source of noise is the mechanical sound of the weapon's bolt or slide. A suppressor cannot influence the acoustics of these final two actions. B&T also has suppressors that are integrated with barrel that are ported near the chamber. This will reduce the speed of 9mm bullets to such an extent that the sound of the bullet breaking the sound barrier does not occur. Suppressed bolt-action weapons when used with subsonic ammunition such as the SPR300 offer minimal noise because there is no mechanical or ballistic noise when fired.

When a bullet leaves the muzzle, there are always some combustible gases and unburned powder particles. When these elements come into contact with the oxygen in the ambient air, they ignite. The resulting muzzle flash can be significantly reduced using suppressors.

Another ballistic phenomenon is when the bullet leaves the muzzle, it is overtaken by the combustion gases. This can destabilize the bullet during flight and reduce accuracy. By slowing down the gases, a suppressor can minimize this disruption to the bullet's flight. The additional mass of the suppressor at the muzzle also reduces barrel vibrations, which can also have a positive effect on the overall accuracy.



PISTOLS / SUBMACHINE GUNS

The passion of our founder and company owner Karl Brügger is pistol caliber carbines, especially in the 9x19 mm caliber. This is reflected not only in the large number of weapons that B&T offers in this caliber, but also in the associated suppressors.

To meet a variety of applications, B&T offers a wide range of suppressor for pistols, submachine guns and pistol caliber carbines. Do you need a custom suppressor? Contact us! Most of the time, we can find a solution using existing components or design complete custom solutions in the shortest possible time!

PISTOLS/SUBMACHINE GUNS

PISTOL SUPPRESSORS

The Classic
– Impuls IIA.



Our Light Suppressor
– Impuls OLS.



The Little Brother
– Impuls VA Mini.



The Flexible
– Impuls XM.



Slim, Light, Quiet
– Jet.



TECHNICAL SPECS

	IMPULS IIA (9MM)	IMPULS IIA COMPACT	IMPULS IIA (.40) ¹	IMPULS IIA (.45) ¹
Caliber	9x19mm	9x19mm	.40 S&W	.45 ACP
Interface	M13,5x1L, 1/2"-28 ²		M14,5x1L ²	M16x1L ²
Diameter	35mm			
Length	199mm	157mm	199mm	
Length past muzzle	185mm	142mm	185mm	
Weight	404g	332g	487g	489g
Suppression³	32dB	28dB	30dB	28dB

	IMPULS OLS	IMPULS OLS COMPACT
Caliber	9x19mm	
Interface	M13,5x1L, 1/2"-28 ²	
Diameter	36mm	
Length	191mm	152mm
Length past muzzle	176mm	137mm
Weight	265g	244g
Suppression³	28dB	21dB

	IMPULS VA MINI
Caliber	.380 ACP
Interface	M12x0,75, 1/2"-28 ²
Diameter	30mm
Length	125mm
Length past muzzle	117mm
Weight	153g
Suppression³	19dB

	IMPULS XM	WITH BOOSTER MODULE
Caliber	9x19mm	
Interface	M13,5x1L, 1/2"-28 ²	
Diameter	36mm	
Length	152mm	191mm
Length past muzzle	138mm	177mm
Weight	237g	298g
Suppression³	22dB	28dB

	JET
Caliber	.32 ACP/380 ACP/9x19mm
Interface	M10x1, M11x1, M12x1, M13x1, M14x1, M13,5x1L, 1/2"-28 ²
Diameter	30mm
Length	152mm
Length past muzzle	142mm
Weight	116g
Suppression³	29dB

¹Suppressor not depicted ²Other threads possible upon request ³Actual suppression may vary due to firearm, barrel length, ammunition and environmental factors

SMG / PCC SUPPRESSORS

Blowback Reduction
– RBS-9.



The Quickest
– RBS-9 SQD.



The Compact Specialist
– RBS MP9/TP9.



Timeless
– SMG/PDW QD.



The Quietest Solution
– SMG Integral.

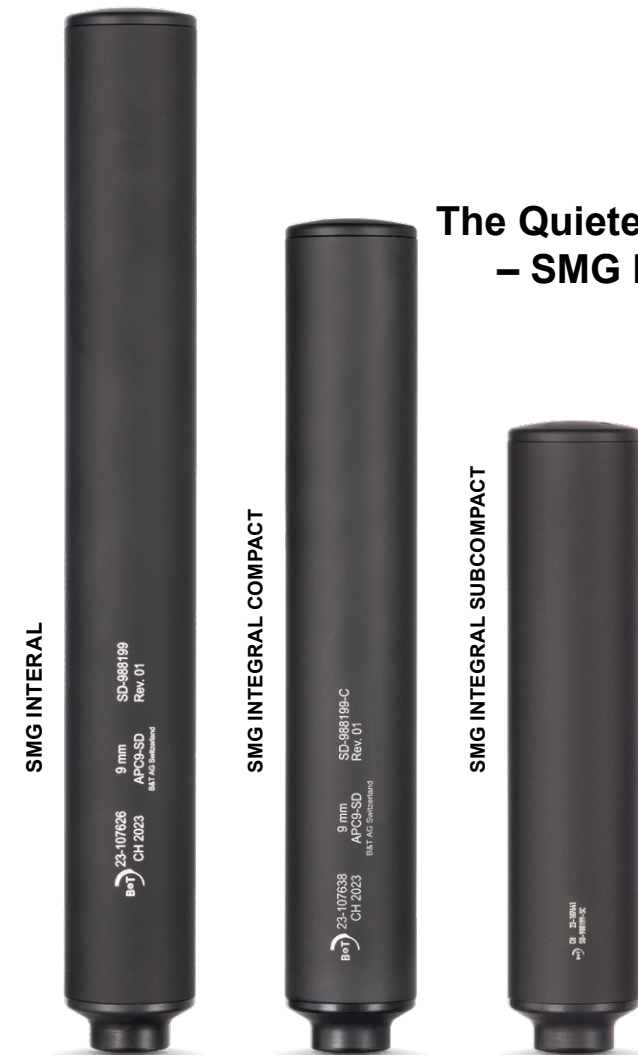

TECHNICAL SPECS

	RBS-9 DM	RBS-9 DM COMPACT	RBS-9 SQD	RBS-9 SQD COMPACT	RBS MP9/TP9
Caliber	9x19mm				
Interface	1/2"-28 ²		3-Lug SQD		MP9/TP9 QD
Diameter	45mm				50mm
Length	196mm	154mm	214mm	157mm	212mm
Length past muzzle	181mm	139mm	179mm	122mm	188mm
Weight	380g	315g	454g	381g	467g
Suppression³	24dB	17dB	24dB	17dB	31dB

	SMG/PDW QD	SMG/PDW QD COMPACT	SMG INTEGRAL	SMG INTEGRAL COMPACT	SMG INTEGRAL SUBCOMPACT
Caliber	9x19mm				
Interface	3-Lug QD		Only for integrally suppressed barrels		
Diameter	35mm		40mm		
Length	210mm	146mm	315mm	252mm	189mm
Length past muzzle	178mm	115mm	–		
Weight	370g	275g	491g	417g	342g
Suppression³	32dB	26dB	–	–	–

¹Suppressor not depicted ²Other threads possible upon request ³Actual suppression may vary due to firearm, barrel length, ammunition and environmental factors



SERVICE RIFLE / MACHINE GUNS

As the main infantry rifles, service rifles are playing a leading role in the spread of firearm suppressors. This is due to their extensive use among police forces and modern armies alike.

The range of models, calibers, barrel lengths and operating systems found in modern service rifle designs contributes to the wide variety of products found in the B&T suppressors range. In addition to the various muzzle interfaces, there are different suppressor designs with different operating parameters for most calibers to choose from. In addition, B&T has recently developed the next generation suppressor. This is the RBS family of suppressor for automatic weapons. More about this on page 25.

BRAND

SERVICE RIFLE/MACHINE GUNS

SERVICE RIFLE INTERFACES

The B&T suppressor families differ among other details in their interfaces.

In contrast to the direct mount (DM) models, the Rotex and MARS-Interfaces allow attaching and detaching suppressors within seconds. You will find a suitable solution for any application. Further information on the following pages.

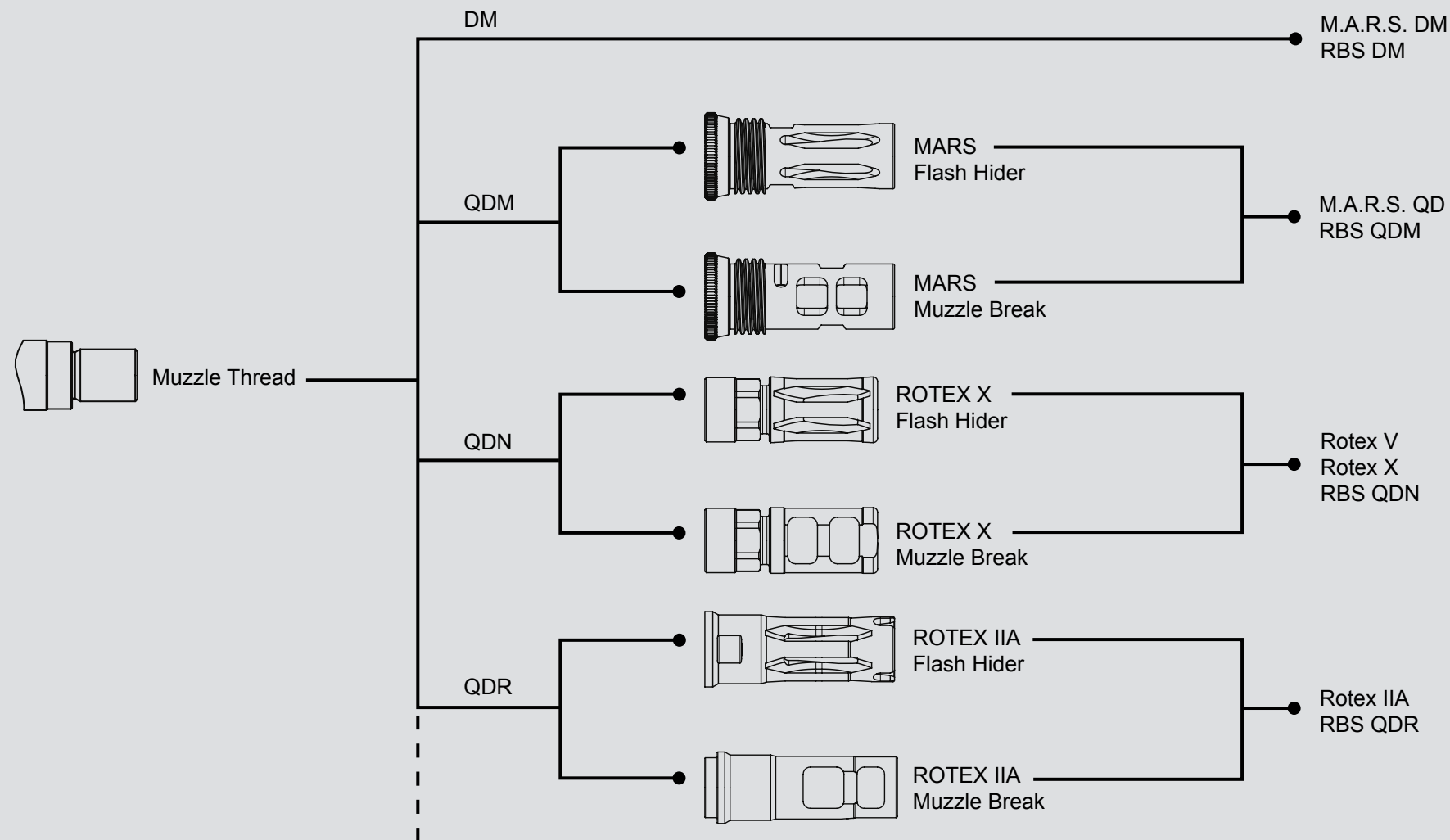

The Rotex-X is the latest generation suppressor for NATO-spec flash hidrs. It delivers the same or better performance and service life than its predecessors while being noticeably lighter.



The Rotex-IIA is the result of demands made by many NATO special operations teams for a suppressor that provides the maximum amount of sound and flash suppression. It will mount on the B&T Rotex-II flash hider and there is a version that fits Surefire flash hidrs.



TECHNICAL SPECS

	ROTEX-X 5.56	ROTEX-X 7.62 ¹	ROTEX-X COMPACT 5.56	ROTEX-X COMPACT 7.62 ¹
Caliber	5.56 mm	7.62 mm	5.56 mm	7.62 mm
Interface	QDN (NATO-Standard)			
Diameter	39 mm			
Length	198 mm		169 mm	
Length past muzzle	151 mm		122 mm	
Weight	565 g	570 g	510 g	515 g
Suppression³	30 dB	25 dB	28 dB	20 dB

	ROTEX-IIA COMPACT 7.62	ROTEX-IIA MICRO 7.62	ROTEX-IIA MICRO 5.56 ¹	ROTEX-IIA 7.62 LIGHTWEIGHT	ROTEX-IIA 5.56 LIGHTWEIGHT
Caliber	7.62 mm		5.56 mm	7.62 mm	5.56 mm
Interface	QDR or Surefire				
Diameter	39 mm				
Length	171 mm	134 mm		213 mm	182 mm
Length past muzzle	105 mm	68 mm		146 mm	115 mm
Weight	590 g	490 g	487 g	510 g	465 g
Suppression³	23 dB	14 dB	20 dB	25 dB	28 dB

¹Suppressor not depicted ²Other threads possible upon request ³Actual suppression may vary due to firearm, barrel length, ammunition and environmental factors

MARS

The B&T M.A.R.S. – Miniature Assault Rifle Suppressor is the newest among the conventional B&T suppressor designs. The QDM interface was developed to allow for an even lighter and more compact suppressor without sacrificing performance or durability. It is available with this interface as well as in direct thread versions.



TECHNICAL SPECS

	MARS DM 7.62	MARS DM COMPACT 7.62 ¹	MARS DM 5.56	MARS DM MICRO 5.56	MARS DM 7.62 LIGHTWEIGHT	MARS DM 5.56 LIGHTWEIGHT
Caliber	7.62mm		5.56mm		7.62mm	5.56mm
Interface	M15x1, 5/8"-24 ²		M15x1, 1/2"-28 ²		M15x1, 5/8"-24 ²	M15x1, 1/2"-28 ²
Diameter	39mm					
Length	142mm	113mm	127mm	104mm	141mm	126mm
Length past muzzle	127mm	98mm	112mm	89mm	126mm	111mm
Weight	455g	370g	397g	340g	335g	295g
Suppression³	18dB	15dB	23dB	15dB	18dB	23dB

	MARS QD 7.62	MARS QD COMPACT 7.62 ¹	MARS QD 5.56	MARS QD 7.62 LIGHTWEIGHT	MARS QD 5.56 LIGHTWEIGHT
Caliber	7.62mm		5.56mm	7.62mm	5.56mm
Interface	QDM (MARS)				
Diameter	39mm				
Length	192mm	163mm		190mm	159mm
Length past muzzle	127mm	98mm		125mm	93mm
Weight	484g	455g	414g	375g	335g
Suppression³	22dB	20dB	25dB	22dB	26dB

¹Suppressor not depicted ²Other threads possible upon request ³Actual suppression may vary due to firearm, barrel length, ammunition and environmental factors

RBS REDUCED BACK-PRESSURE SUPPRESSOR

Conventional Suppressor

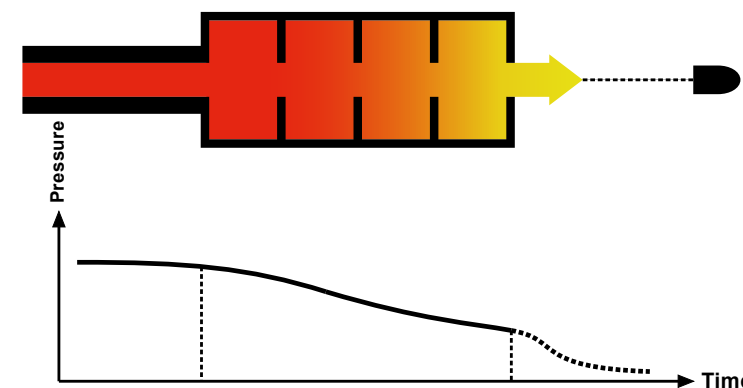

Conventional suppressors decelerate the combustion gases at the muzzle leading to build up of backpressure. This causes an increase in bolt velocity and cyclic rate in self-loading firearms, especially gas-operated ones. Some of the pressure remains until the bolt is unlocked. This causes combustion gases to exit through the ejection port toward the operator. This phenomenon is referred to as blowback and it can lead to irritation in the shooter's eyes and respiratory system.

RBS Suppressor

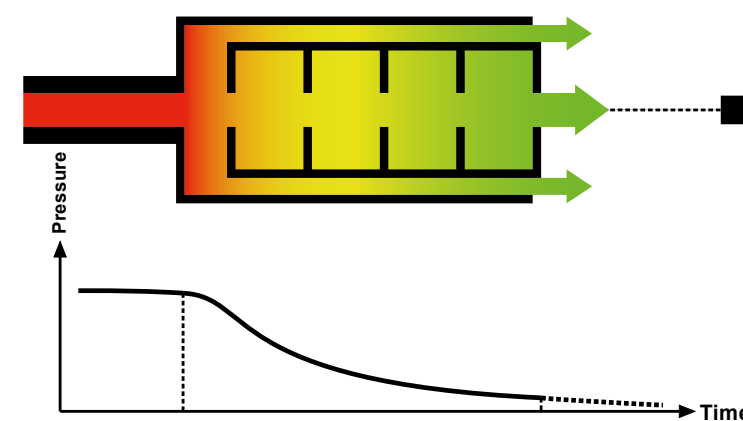

To minimize blowback, B&T developed and patented the Reduced Backpressure Suppressor – RBS. Unlike conventional suppressors, RBS suppressors bleed off gases from the initial blast chamber, thus bypassing the core baffles. This leads to a rapid decrease in pressure which in turn leads to less gas being expelled towards the shooter. Another advantage of the reduced backpressure is, that the weapon function is barely affected by the use of the suppressor. This means an adjustable gas system is not required to prevent over function or excessive wear in the firearm.

The RBS family of suppressors represents the latest evolution in the B&T product portfolio. To ensure every customer can take advantage of this development regardless of their weapon platform, RBS are manufactured with direct thread and all quick detach interface options as well as custom solutions upon request.



TECHNICAL SPECS

	RBS DM 7.62	RBS DM 5.56	SRBS DM 7.62	SRBS DM 5.56 ¹
Caliber	7.62mm	5.56mm	7.62mm	5.56mm
Interface	M15x1, 1/2"-28, 5/8"-24 ²			
Diameter	52mm		44mm	
Length	171mm	141mm	173mm	
Length past muzzle	152mm	122mm	150mm	154mm
Weight	535g	465g	457g	475g
Suppression³	22dB	21dB	19dB	20dB

	RBS QDN 7.62	RBS QDN COMPACT 7.62	RBS QDN 5.56	SRBS QDN 5.56
Caliber	7.62mm		5.56mm	
Interface	QDN (NATO-Standard)			
Diameter	52mm			44mm
Length	202mm	165mm	168mm	176mm
Length past muzzle	155mm	118mm	121mm	129mm
Weight	670g	560g	570g	550g
Suppression³	23dB	18dB	22dB	24dB

	RBS QDM 7.62 ¹	RBS QDM 7.62 COMPACT ¹	RBS QDM 5.56	RBS QDM 5.56 COMPACT	SRBS QDM 5.56
Caliber	7.62mm		5.56mm		
Interface	QDM (MARS)				
Diameter	52mm				44mm
Length	196mm	167mm	195mm	166mm	170mm
Length past muzzle	130mm	105mm	129mm	105mm	108mm
Weight	545g	488g	550g	490g	437g
Suppression³	24dB	19dB	30dB	23dB	25dB

	RBS QDR	RBS QDR STGW90	RBS UN STGW90 ¹	RBS UN STGW90 COMPACT ¹
Caliber	7.62mm	5.56mm		
Interface	QDR/Surefire	Stg90 Flash Hider		
Diameter	52mm			
Length	202mm	176mm	213mm	183mm
Length past muzzle	155mm	125mm	155mm	125mm
Weight	535g	604g	680g	610g
Suppression³	23dB	29dB	31dB	26dB

¹Suppressor not depicted ²Other threads possible upon request ³Actual suppression may vary due to firearm, barrel length, ammunition and environmental factors

MG

Due to the enormous thermal influences, machine guns place the highest demands on suppressor designs and materials. B&T has accepted this challenge. The result is a range of suppressors that meet the highest requirement. In order to ensure the proper function of the weapon, B&T's patented RBS technology is used. The calibers that are currently covered range from 5.56 mm (.223 Rem.) to 12.7 mm NATO (.50 BMG).

MG



SUPPRESSOR DUMMIES

B&T offers a wide range of training suppressors and blast deflectors for all applications. This is regardless of whether it is mounted on an inert manipulation weapon, a blue gun for FX or UTM training ammunition or a live weapon, B&T has a training option. These products have no baffles and do not reduce sound. It will focus the energy directly forward of the shooter. These products correspond to the exact size and weight to the live counterparts and provide an excellent way for the most realistic training possible.

SUPPRESSOR DUMMIES



TECHNICAL SPECS

	RBS DM MINIMI 7.62 ¹	RBS DM MAG58/M240 ¹	RBS DM MINIMI 5.56	RBS UN MINIMI 5.56	RBS50 M2A1
Caliber	7.62mm		5.56mm		12.7mm
Interface	25/32"-24 ²		9/16"-24L ²	Minimi FD	1-1/8"-12 L ²
Diameter	52mm				69mm
Length	190mm	172mm	152mm	212mm	285mm
Length past muzzle	155mm		125mm		234mm
Weight	590g	580g	540g	680g	2200g
Suppression³	21dB	20dB	18dB	22dB	14dB

¹Suppressor not depicted ²Other threads possible upon request ³Actual suppression may vary due to firearm, barrel length, ammunition and environmental factors

The models shown are examples. We offer you training versions of all of our suppressors that correspond to the live models in terms of dimensions, weight, coupling and handling.

CUSTOM SOLUTIONS

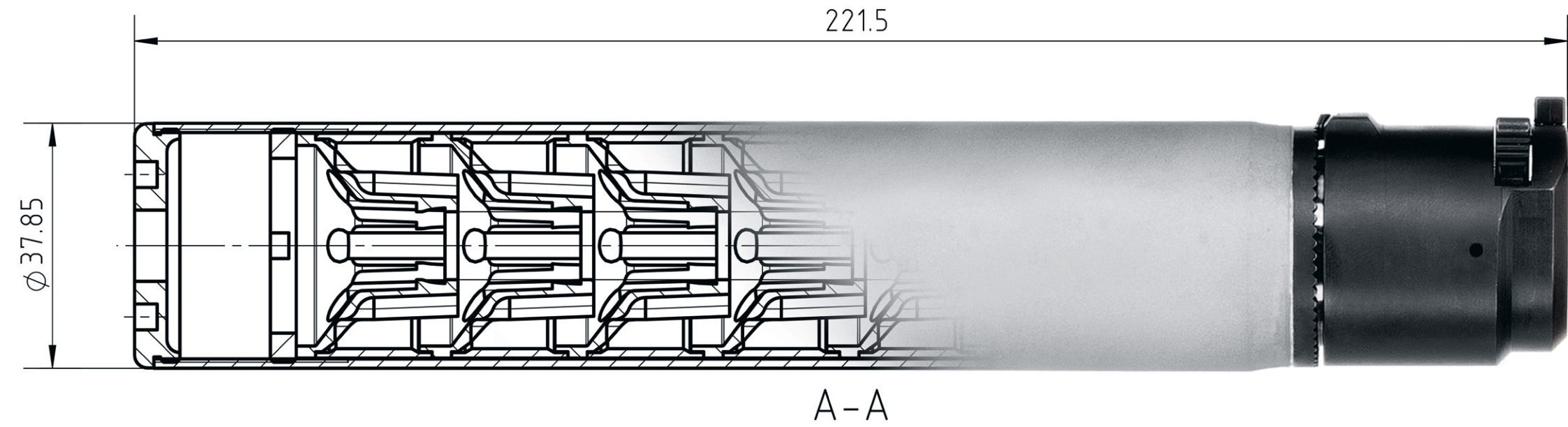

Firearm requirements and applications can be diverse and often vary greatly. B&T has a wide array of products that range from whisper quiet small caliber firearm suppressors to suppressors for crew served machine guns and to the heavy .50 BMG anti-material rifle.

Experience however shows that change is the only constant in life, customer demands are constantly evolving. B&T thrives pushing the envelope. Our product portfolio is always changing to meet your requirements. You are looking for a custom solution for your specific mission, don't hesitate to ask! B&T is not intimidated by any technical challenge!

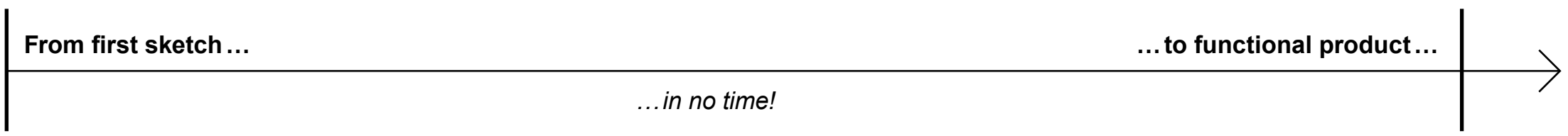



ADDED VALUE...

The recent development of additive manufacturing techniques a.k.a. 3D printing has had a massive impact on engineering and manufacturing in most industries. It allows an almost limitless design freedom in the development of new products. This is particularly true in suppressor design.

B&T has recently invested heavily in new Direct Metal Laser Sintering (DMLS) technology to stay on the cutting edge of suppressor technology. These machines will make the introduction of new products even faster and more innovative. The technology will reduce the development time from CAD drawing to finished product from many weeks to a few days. Printed suppressors are in no way inferior to their traditionally manufactured counterparts. Thanks to high-temperature-resistant alloys such as Inconel, even the toughest requirements can be met. We are looking forward to receiving your requirements!

CUSTOM SOLUTIONS

We love special solutions! From the smallest caliber to the largest (currently 4.6mm/.17 to 12.7mm/.50) we cover an extremely wide range of solutions regarding calibers, interfaces, materials and designs. If you have a requirement that is not met by any current suppressor design, contact us. We are sure that we can find a solution together!

MP7 LMX



B&T 23-97967 4.6mm x 30 SD-123198
 CH 2022 Rotex-LMX Rev. 02
 MP7
 B&T AG Switzerland

	MP7 LMX
Caliber	4.6 mm
Interface	MP7 Flash Hider
Diameter	39 mm
Length	189 mm
Length past muzzle	150 mm
Weight	395 g
Suppression ³	37 dB

.50 QD

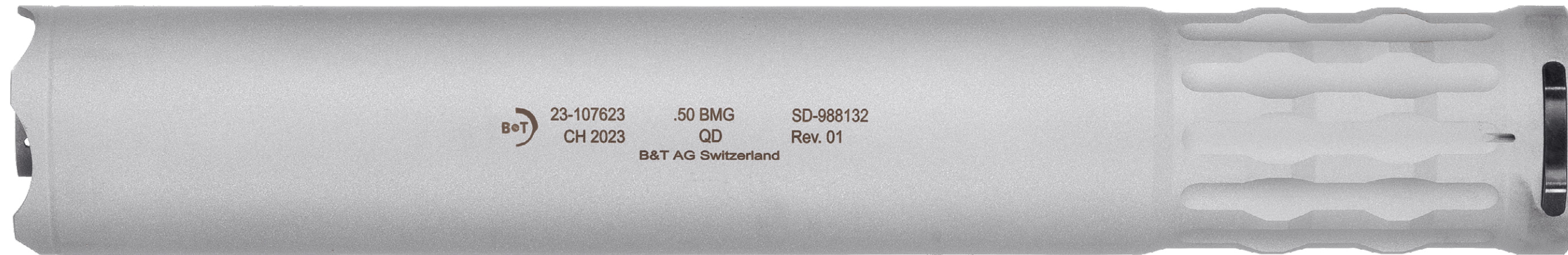

B&T 23-107623 .50 BMG SD-988132
 CH 2023 QD Rev. 01
 B&T AG Switzerland

	.50 QD
Caliber	12.7 mm
Interface	QD Muzzle Break
Diameter	57 mm
Length	354 mm
Length past muzzle	254 mm
Weight	2180 g
Suppression ³	>30 dB

³Actual suppression may vary due to firearm, barrel length, ammunition and environmental factors





HUNTING / PRECISION RIFLES

The laws in many countries have changed in recent years to allow ownership and use of suppressors. Hunting with suppressors is not only legal in many European countries but is quickly becoming the norm.

We expressly welcome and support this development. No matter if quiet .22 or powerful big game caliber, suppressors reduce muzzle report, flash and recoil and significantly improve practical accuracy. To meet hunting, target and tactical requirements, B&T has developed a range of suppressors primarily designed for bolt action rifles. If you are plinking, hunting or long-range shooting, with our hunting and precision rifle suppressors you can't go wrong!

HUNTING / PRECISION RIFLES

B&T hunting and precision rifle suppressors cover everything from small game hunting to long-range shooting. These products are not just accurate and lightweight but also feature a great price-performance ratio! You can choose from a wide range of caliber and thread options to find the ideal solution for any application.



TECHNICAL SPECS

	TIGER	STARLITE
Caliber	.22lr	.17 HMR/Hornet .22 WMR/Hornet
Interface	1/2"-20, 1/2"-28, M9x0.75,... ²	
Diameter	30 mm	35 mm
Length	152 mm	157 mm
Length past muzzle	140 mm	137 mm
Weight	101 g	220 g
Suppression ³	29 dB	28 dB

	LAS ¹	STARLITE	OHS	MONOBLOCK
Caliber	9mm/.38	6.2 mm 7.62 mm 9.3 mm	7.62 mm	7.62 mm 8.6 mm
Interface	M14x1, M15x1, 1/2"-28, 5/8"-24,... ²			QD Muzzle Break
Diameter	50 mm			
Length	180 mm		200 mm	297 mm
Length past muzzle	157 mm		149 mm	221 mm
Weight	550 g	490 g	450 g	652 g 645 g
Suppression ³	23 dB	28 dB 26 dB	29 dB	30 dB 28 dB

¹Suppressor not depicted ²Other threads possible upon request ³Actual suppression may vary due to firearm, barrel length, ammunition and environmental factors

Is is not the big eating the small,
but the fast overtaking the slow.

B&T
Tempelstrasse 6
3608 Thun
Schweiz
Tel. +41 33 334 67 00
info@bt-ag.ch

B&T USA
6801 N 54th St,
Tampa FL 33610
Phone +1 813 653 1200
sales@bt-usa.com

B&T Shop
Zelglistrasse 10
3608 Thun
Schweiz
Tel. +41 33 334 67 30
shop@bt-ag.ch

Online
Catalogue



bt-ag.ch

