

APC9/10/40/45 PRO HA

OPERATOR MANUAL



B&T AG
3608 Thun • Switzerland
Tel +41 33 334 67 00
info@bt-ag.ch
www.bt-ag.ch

Table of content

1. General rules	5
1.1 Safety rules	5
1.2 Maintenance rules	5
2. Technical specifications	6
2.1 Overview - APC9/10/40/45	6
2.2 General description	6
2.3 General technical data	7
2.3.1 Technical data - APC9 PRO HA	8
2.3.2 Technical data - APC10 PRO G HA	8
2.3.3 Technical data - APC40 PRO G HA	9
2.3.4 Technical data - APC45 PRO HA	9
2.4 Variant overview	10
3. Nomenclature	12
3.1 Weapon complete	12
3.2 Weapon disassembled	12
4. Handling and operating procedures	13
4.1 Clearing weapon	13
4.2 Operating fire selector	13
4.3 Magazine catch	14
4.3.1 Operating magazine catch	14
4.3.2 Magazine catch standard magazine	14
4.3.3 Magazine catch Glock magazine	14
4.3.4 Magazine catch SIG magazine	14
4.4 Stock / Adapter	15
4.4.1 Close folding stock (standard)	15
4.4.2 Open folding stock (standard)	15
4.4.3 Closing stock - Stock PRO	16
4.4.4 Adjusting length - Stock PRO	16
4.4.5 Adjusting cheek rest - Stock PRO	17
4.4.6 Opening stock - Stock PRO	17
4.4.7 Retracting telescopic stock	18
4.4.8 Extracting telescopic stock	18
4.4.9 Closing helmet stock	19
4.4.10 Opening helmet stock	19
4.4.11 Closing folding stock (Skeleton)	20
4.4.12 Opening helmet stock (Skeleton)	20
4.4.13 Close foldable M4-Adapter	21
4.4.14 Opening foldable M4-Adapter	21
4.5 Pistol grip storage compartment	22
4.5.1 Open the pistol grip cover	22
4.5.2 Close the pistol grip cover	22

4.6	Iron sights	23
4.6.1	Engaging iron sights.....	23
4.6.2	Adjustments.....	23
4.7	Bolt catch.....	24
4.7.1	Holding bolt in open position	24
4.7.2	Closing bolt.....	24
4.8	Loading and unloading weapon	25
4.8.1	Loading weapon.....	25
4.8.2	Unloading weapon during firing sessions.....	25
4.8.3	Unloading weapon for storage.....	26
4.9	Firing the APC9 PRO	26
5.	Maintenance procedures	27
5.1	Disassembly.....	27
5.1.1	Disassembly of the weapon	27
5.1.2	Disassembly upper receiver.....	29
5.1.3	Disassembly upper receiver with suppressor	30
5.2	Cleaning and inspections.....	31
5.3	Reassembly.....	31
5.3.1	Reassembly of the weapon.....	31
5.3.2	Assembly upper receiver	33
5.3.3	Assembly upper receiver with suppressor.....	34
5.4	Functional check	35
5.5	Troubleshooting table	36
6.	Accessories.....	37
6.1	Suppressors.....	37
6.2	Stocks / Adapters	38
6.3	Magazines.....	40
6.4	Grips	41
6.5	Flashlights.....	42
6.6	Brass catcher	42
6.7	Flash hider.....	42
6.8	Sights	43
6.9	Maintenance	43
7.	Warranty statement	44

Related documents:

Parts catalogue PC-APC9 PRO-HA-EN
Parts catalogue PC-APC10 PRO G-HA-EN
Parts catalogue PC-APC40 PRO G-HA-EN
Parts cataloguePC-APC45 PRO-HA-EN

ADVICE!	
	<p>This operator manual covers the entire APC9/10/40/45 weapon family. On the Pictures show normally the Standard Version. Where necessary the operating steps are shown separately for the different variants</p> <p>Due to continuous efforts to improve the weapon, it is possible that certain descriptions in this manual may differ from the actual weapon.</p>

Abbreviations

- POA: Point of Aim
- POI: Point of Impact
- MPI: Mean Point of Impact
- Left / right side: Defined looking in firing direction.

EYE PROTECTION MUST BE WORN!	
	<p>SAFETY GOGGLES MUST BE WORN WHEN DISASSEMBLING AND REASSEMBLING THE GUN. PARTS CAN GET INTO THE EYES IF HANDLED INCORRECTLY.</p>

EAR PROTECTION MUST BE WORN!	
	<p>SUITABLE HEARING PROTECTION MUST ALWAYS BE WORN WHEN SHOOTING WITH A FIREARM.</p>

1. General rules

READ MANUAL BEFORE USE.

1.1 Safety rules

1. Consider every weapon loaded until checked personally by the individual operator.
2. Always keep fingers off the trigger and outside the trigger guard until the sights are on target.
3. Always point the weapon in a safe direction.
4. Verify your target and the backstop.
5. Before firing always verify the serviceability and condition of both the weapon and ammunition.
6. Hearing and eye protection are mandatory.
7. Be sure to use NATO, SAAMI or CIP certified cartridges of correct caliber only.

SAFETY ADVICE!	
	Defects that can be traced back to the use of non NATO, SAAMI or CIP ammunition (especially reloaded cartridges) are not covered by the guarantee!

8. If a cartridge fails to ignite, keep the muzzle pointed in a safe direction and open the chamber only after a minimum of 30 seconds.
9. Live fire training should be carried out in open or well-ventilated areas to prevent excessive exposure to toxic gases.
10. Operate your weapon consciously and do not use excessive force.

1.2 Maintenance rules

1. The weapon is to be cleaned after each deployment or firing.
2. Any malfunctions are to be reported to the unit armorer or manufacturer.
3. The weapon is to be presented to the unit armorer for inspection after each mission or a minimum of once per year.

2. Technical specifications

2.1 Overview - APC9/10/40/45



2.2 General description

The APC9/10/40/45 is a semi-automatic only pistol caliber carbine (PCC)

The working principle is recoil operation:

The recoil of a fired projectile is driving the bolt rearward. When traveling back, the bolt extracts and ejects the case of the fired cartridge, compresses the mainspring and cocks the internal hammer of the single action trigger group. At the very end of the bolt's travel, a hydraulic recoil buffer is stopping it gently and the compressed mainspring drives the bolt back against the barrel. While traveling forward, the bolt feeds a new cartridge out of the magazine into the chamber of the barrel. After completion of such a cycle, the weapon is loaded and armed.

The next shot is released by pulling the trigger.

The weapon has mechanical flip up sights, an additional reflex sight can be mounted on the accessory rail. The reflex sight can be included in the scope of delivery, depending on the version of the weapon.

Controls such as bolt catch, magazine catch, fire selector and charging handle are designed ambidextrous.

2.3 General technical data

Designation	APC_PRO HA
Manufacturer	B&T AG - Switzerland
Operating system	Recoil operated, closed bolt blowback action
Sights	Flip-up iron sight with two aperture holes
Bore height	72 mm
Rail height	38 mm
Interfaces	2 NATO Accessory rails
Scope of delivery	Weapon with magazines, carrying sling, cleaning kit, case

Stock Options	Stock length			Stock width		Weight difference to Standard
	retracted	extracted	folded / retracted	folded out / retracted	folded / retracted	
	[mm]					
Folding stock (standard)	240	n.v.	30	62	102	0
Teleskopic stock**	n.v.	232	53	54	n.v.	+147
Fold- retractable stock**	202	242	31	62	103	+253
Fold- retract. stock PRO**	193	270	30	52	84	+100
Fixed stock	247	n.v.	n.v.	62	n.v.	+90
Folding stock Skeleton	230	n.v.	36	38	53	-90
Helmet stock**	218	293	31	62	103	-20
M4-Adapter foldable***	59	n.v.	30	62	102	-150
NAR-Adapter	18	n.v.	n.v.	38	n.v.	-230
M4-Adapter***	30	n.v.	n.v.	62	n.v.	-150

**Extracted to the maximum, intermediate positions existent

*** Without M4 stock.

The overall length is determined by adding the receiver length and the stock length.

Technical data are provided for information only and shall not serve as acceptance criteria.

2.3.1 Technical data - APC9 PRO HA

Designation	APC9 PRO HA
Product ID	BT-36043
Caliber	9x19 mm
Magazine capacity	15/30 round
Rifling	6 Grooves, right hand twist

Typ		Standard	Short «K»	Long «K»	SD US	Silenced «SD»
Barrel length	[mm]	175	138	240	146	146
Length standard	[mm]	597	373	662	442	767
Length receiver	[mm]	357	320	422	412	526
Width	[mm]	62	57	62	62	62
Height*	[mm]	215	215	215	215	215
Weight	[kg]	2.7	2.78	2.89	2.33	3.17

* Without magazine, flip-up sights folded.

2.3.2 Technical data - APC10 PRO G HA

Designation	APC10 PRO G HA
Product ID	BT-36049
Caliber	10 mm AUTO
Magazine capacity	15 round
Rifling	6 Grooves, right hand twist

Barrel length	[mm]	175
Length standard	[mm]	612.5
Length receiver	[mm]	372
Width	[mm]	60
Height*	[mm]	215
Weight	[kg]	2.68

* Without magazine, flip-up sights folded.

2.3.3 Technical data - APC40 PRO G HA

Designation	APC40 PRO G HA
Product ID	BT-36026
Caliber	.40 S&W
Magazine capacity	22 round
Rifling	6 Grooves, right hand twist

Barrel length	[mm]	175
Length standard	[mm]	597
Length receiver	[mm]	357
Width	[mm]	62
Height*	[mm]	215
Weight	[kg]	3.18

* Without magazine, flip-up sights folded.

2.3.4 Technical data - APC45 PRO HA

Designation	APC45 PRO HA
Product ID	BT-361356
Caliber	.45 ACP
Magazine capacity	15/30 round
Rifling	6 Grooves, right or left hand twist

Barrel length	[mm]	175
Length standard	[mm]	597
Length receiver	[mm]	357
Width	[mm]	62
Height*	[mm]	215
Weight	[kg]	2.42

* Without magazine, flip-up sights folded.

2.4 Variant overview

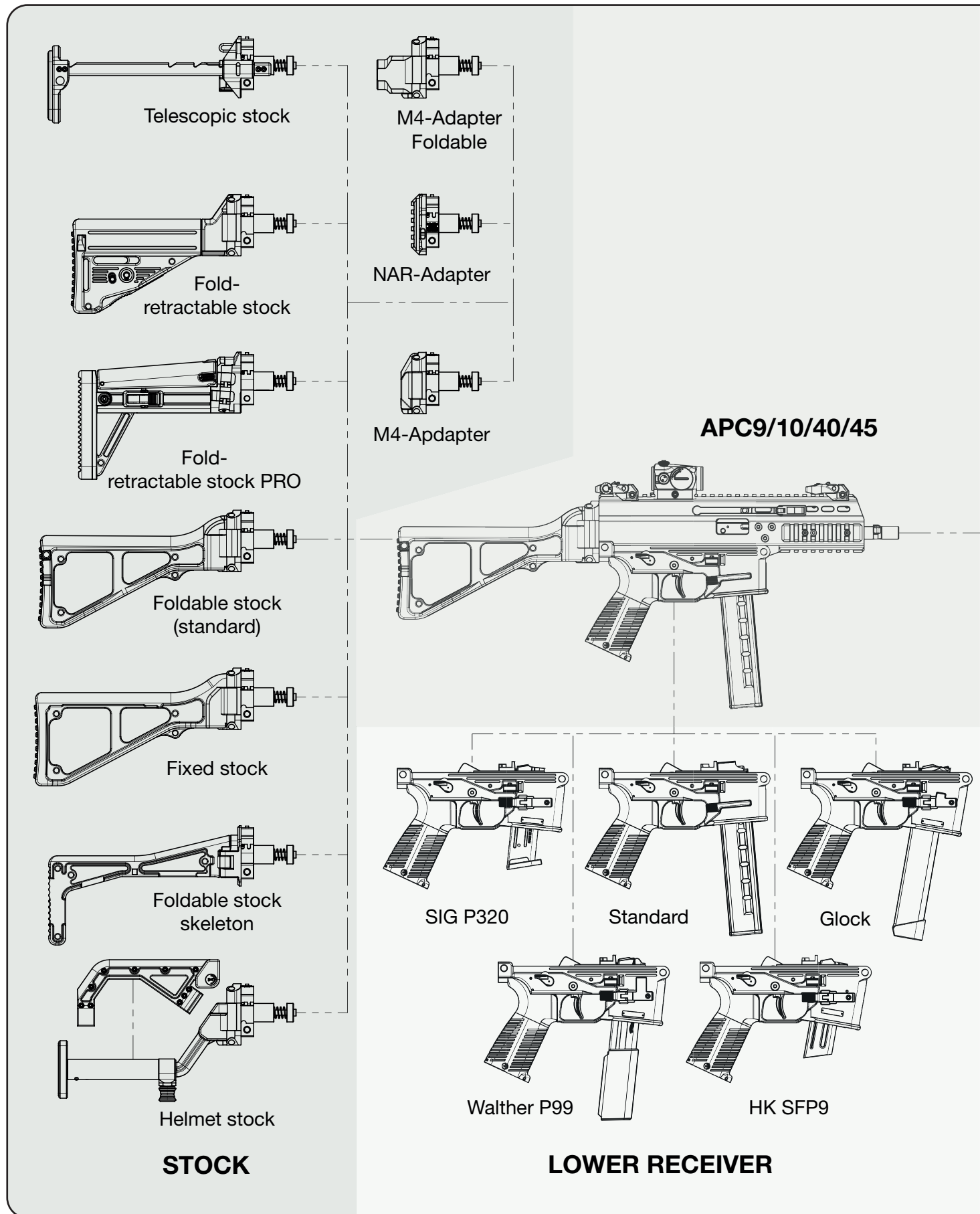

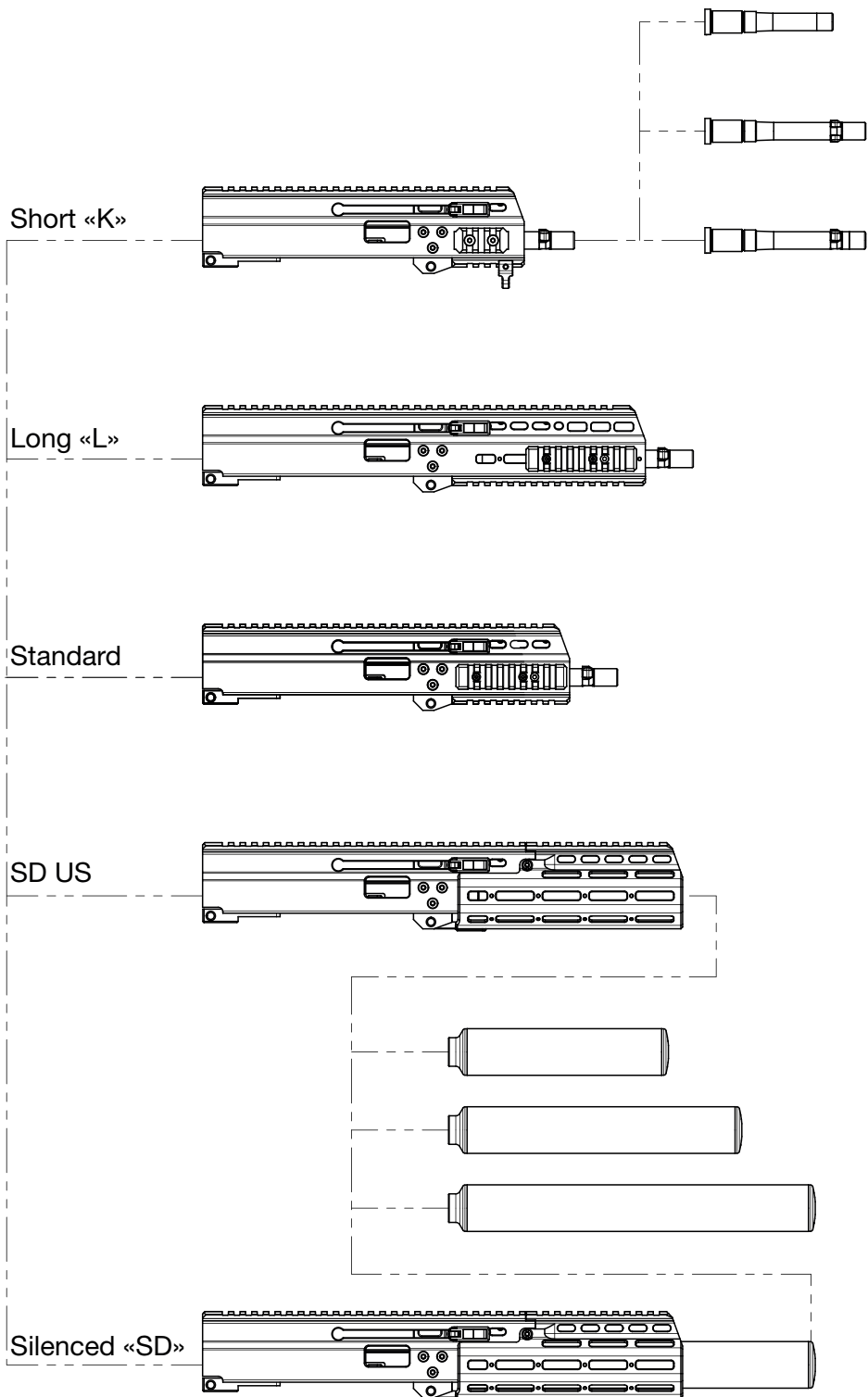

UPPER RECEIVER

3. Nomenclature

3.1 Weapon complete



3.2 Weapon disassembled

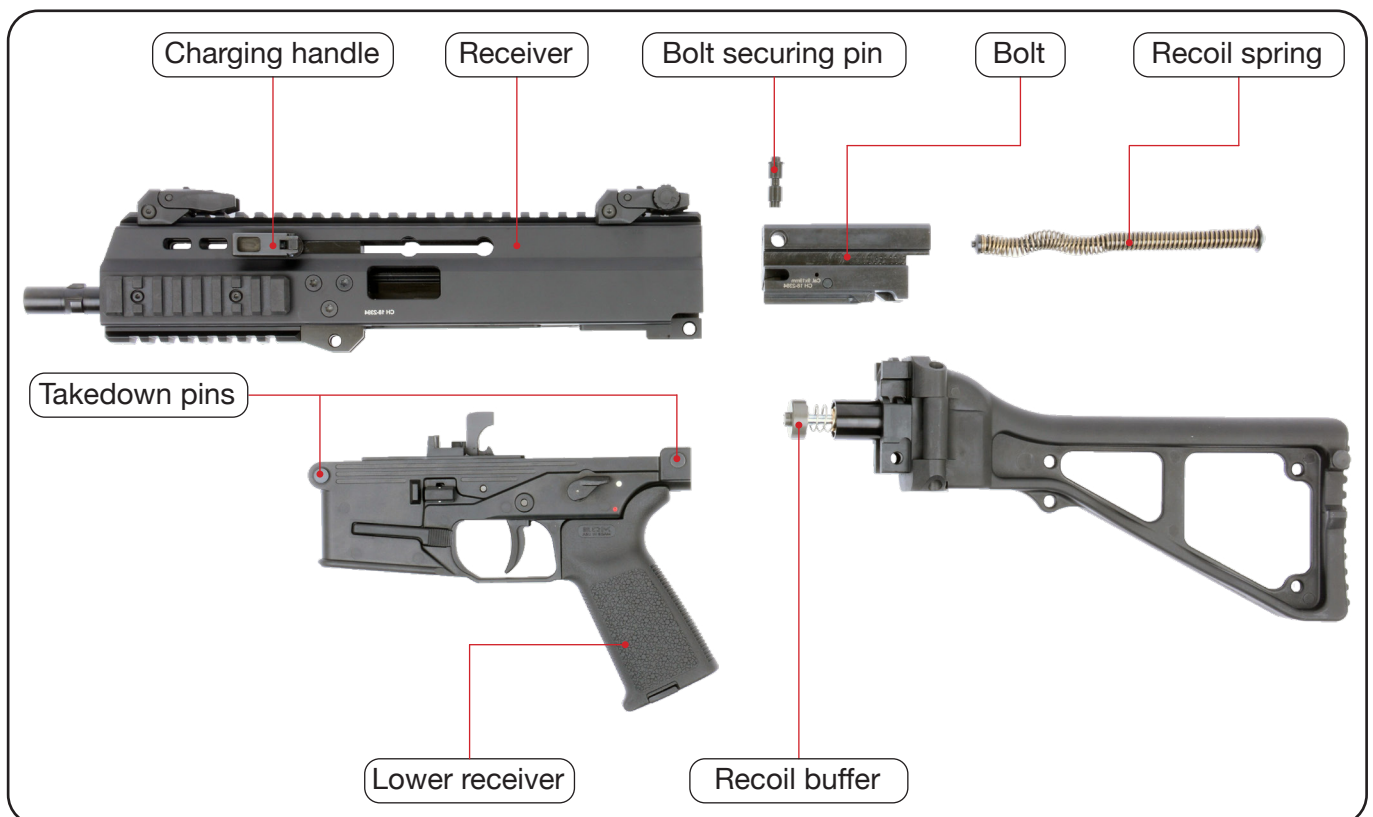

4. Handling and operating procedures

4.1 Clearing weapon

- Rotate the fire selector to «safe» position (see chapter „4.2 Operating fire selector“ on page 13).
- Press the magazine retainer and pull the magazine downward out.

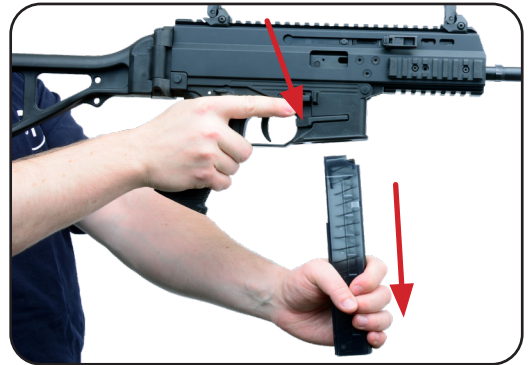

- Pull the charging handle completely to the rear and inspect the chamber visually to be clear.
- Lock the bolt in open position (see chapter „4.7 Bolt catch“ on page 24).



4.2 Operating fire selector

- The positions of the fire selector are marked on both side of the weapon.
- Rotate the fire selector in order to engage the desired mode.



WHITE DOT = SAFE

RED DOT= SINGLE FIRE

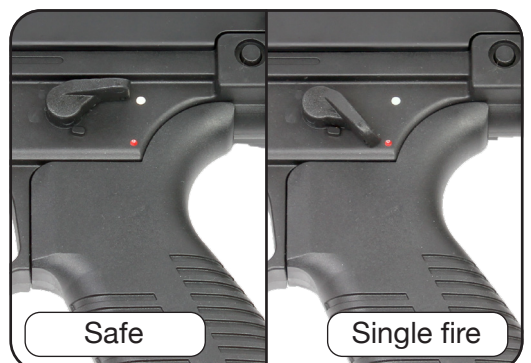

4.3 Magazine catch

4.3.1 Operating magazine catch

- Rotate the fire selector to «safe» position (see chapter „4.2 Operating fire selector“ on page 13).
- Press the magazine retainer and pull the magazine downward out.



4.3.2 Magazine catch standard magazine

- Magazine catch of the standard magazine on left and right side of the lower receiver.

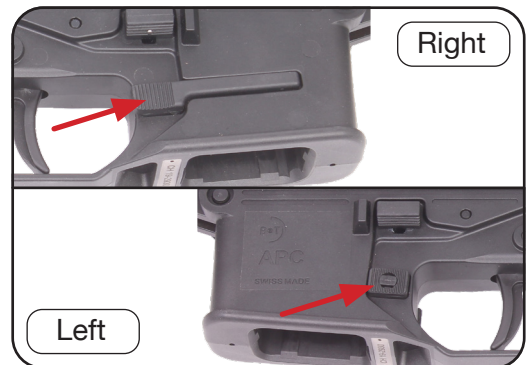

4.3.3 Magazine catch Glock magazine

- Magazine catch of the Glock magazine on left and right side of the lower receiver.

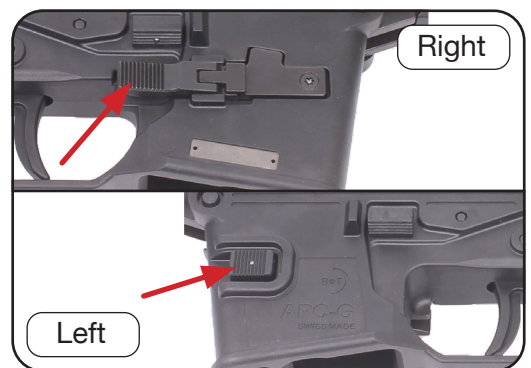

4.3.4 Magazine catch SIG magazine

- Magazine catch of the SIG magazine on left and right side of the lower receiver.

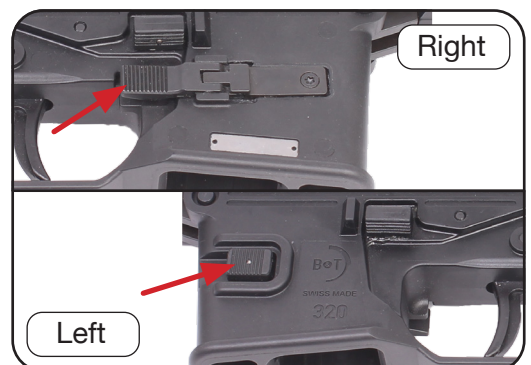

4.4 Stock / Adapter

4.4.1 Close folding stock (standard)

- a. Grasp the weapon with the firing hand on the pistol grip.
- b. Push the locking knob with the non firing hand, and fold the stock



- c. Fold in the stock until it reaches the end position and locks audibly.



4.4.2 Open folding stock (standard)

- a. Grasp the weapon with the firing hand on the pistol grip.
- b. Grasp the folding stock with the non firing hand, and fold it out.

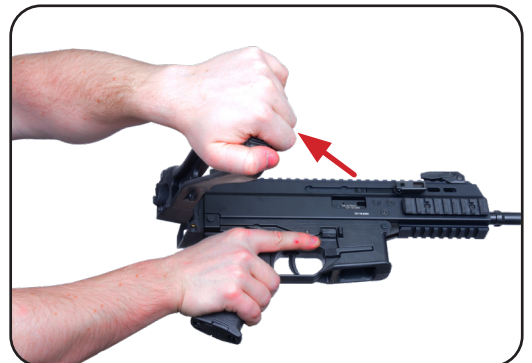

- c. Fold out the stock until it reaches the end position and locks audibly.
- d. Use the non-firing hand to check the correct locking of the stock.



4.4.3 Closing stock - Stock PRO

- a. Grasp the weapon with the firing hand on the pistol grip.
- b. Push the locking knob with the non firing hand, and fold the stock.

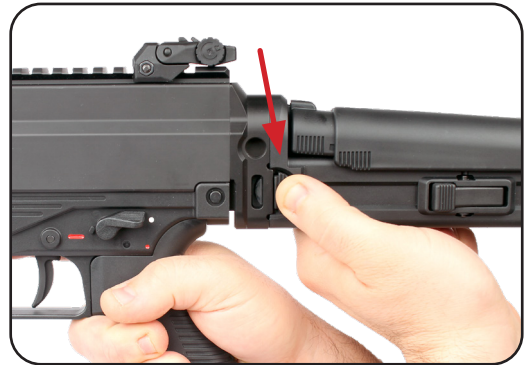

- c. Fold the stock until it reaches the end position and slides in the locked position.



4.4.4 Adjusting length - Stock PRO

- a. Press and hold both locking knobs with one hand.



- b. With the other hand pull out or push in the shoulder support to the desired length.
- c. At the position, release the locking knobs and ensure that the shoulder support is locked in place by pulling gently on it.



4.4.5 Adjusting cheek rest - Stock PRO

- a. Hold the weapon with the firing hand on the pistol grip.
- b. Press and hold the adjustment knob on the cheek rest with the other hand.



- c. Adjust the cheek rest until it audibly engages in the desired position.



4.4.6 Opening stock - Stock PRO

- a. Hold the weapon with the firing hand on the pistol grip.
- b. With the other hand, grasp the folding stock at the interface, lift it upwards out of the lock and unfold it until it audibly engages.



- c. Use the non-firing hand to check the correct locking of the stock.



4.4.7 Retracting telescopic stock

- a. Grasp the weapon with the firing hand on the pistol grip.
- b. Push the locking knob with the thumb of the firing hand, and push in the stock.



- c. Push in the stock until it reaches the end position and locks audibly.



4.4.8 Extracting telescopic stock

- a. Grasp the weapon with the firing hand on the pistol grip.
- b. Pull out the stock with the non firing hand.



- c. Pull out the stock until it reaches the desired position.
- d. Then release the locking knob and lock the stock on one of the various locking positions.



4.4.9 Closing helmet stock

- a. Grasp the weapon with the firing hand on the pistol grip.
- b. Pull the adjustment knob with your non firing hand and retract the stock as far as it will go.
- c. Push the Locking knob with the non firing hand, and fold it.
- d. Fold in the stock until it reaches the end position.

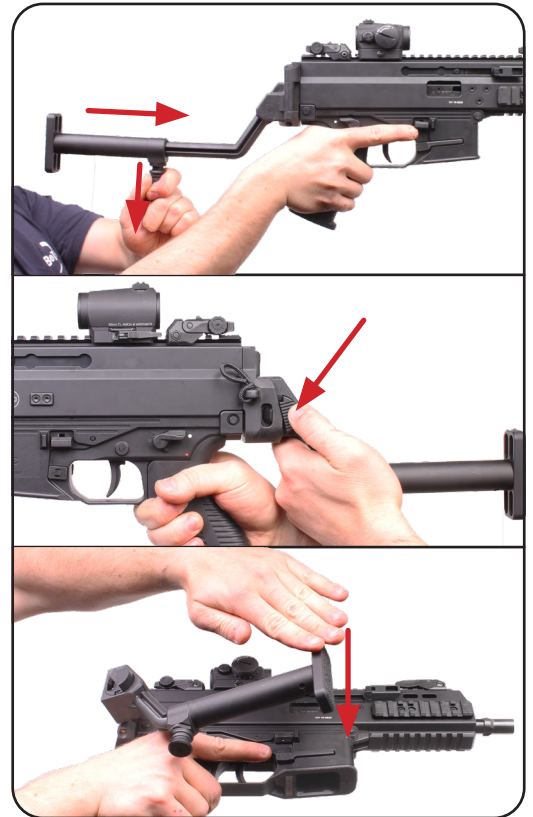

4.4.10 Opening helmet stock

- a. Grasp the weapon with the firing hand on the pistol grip.
- b. Grasp the the end of the stock with the non firing hand, and fold it out the stock.
- c. Fold out the stock until it reaches the end position and locks audibly.
- d. Use the non-firing hand to check the correct locking of the stock.
- e. Pull the adjustment knob with the non firing Hand an pull out the stock until it reaches the desired position.

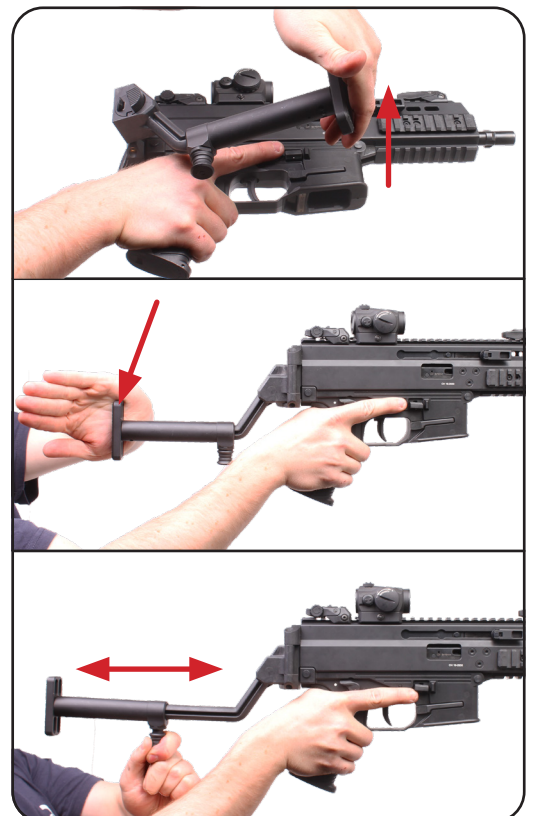

4.4.11 Closing folding stock (Skeleton).

- a. Grasp the weapon with the firing hand on the pistol grip.
- b. Push the Locking knob with the non firing hand, and fold it.

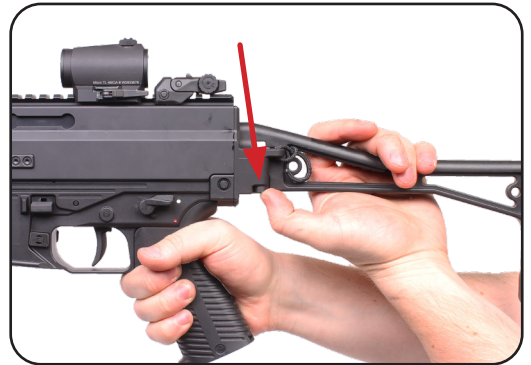

- c. Fold in the stock until it reaches the end position and locks audibly.

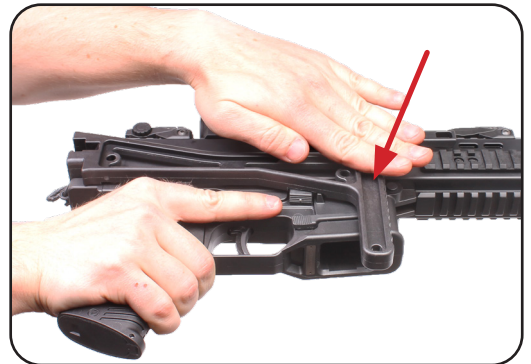

4.4.12 Opening helmet stock (Skeleton)

- a. Grasp the weapon with the firing hand on the pistol grip.
- b. Grasp the the end of the stock with the non firing hand, and fold it out the stock.



- c. Fold out the stock until it reaches the end position and locks audibly.
- d. Use the non-firing hand to check the correct locking of the stock.



4.4.13 Close foldable M4-Adapter

ADVICE!



The operation of an M4 stock mounted on the stock adapter can be found in the operating manual of the respective stock.

- a. Grasp the weapon with the firing Hand on the pistol grip, push the Locking knob with the other hand, and fold it.
- b. Fold the M4 Adapter until it reaches the end position.



4.4.14 Opening foldable M4-Adapter

- a. Grasp the weapon with the firing Hand on the pistol grip.
- b. Grasp the the end of the M4-Adapter with the non firing hand, and fold it out the stock.



- c. Fold out the M4-Adapter until it reaches the end position and locks audibly.
- d. Use the non-firing hand to check the correct locking of the M4-Adapter.



4.5 Pistol grip storage compartment

4.5.1 Open the pistol grip cover

- Slide a screw driver in the gap at the front of the compartment cover.
- Push the cover backward and lift it up.
- In order to close the cover, push it back until it audibly snaps into closed position.



4.5.2 Close the pistol grip cover

- In order to close the cover, push it back until it audibly snaps into closed position.



4.6 Iron sights

4.6.1 Engaging iron sights

a. Push front sight up until it snaps in upright position.

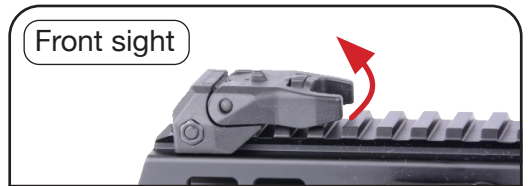

b. Push rear sight up until it snaps in upright position.



c. Select large or small aperture.

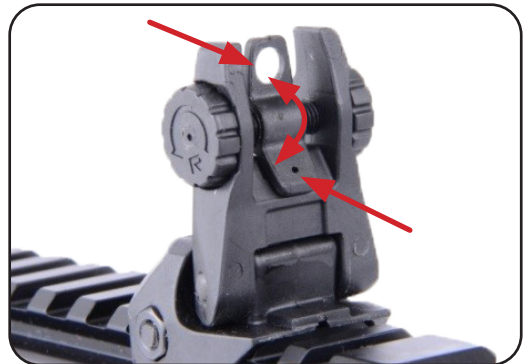

4.6.2 Adjustments

a. Turn the adjusting wheel in the front sight in the direction of the arrow «UP» to raise the MPI.



b. Turn the rear sight wheel in the direction of the arrow «R» to move the MPI to the right.



4.7 Bolt catch

4.7.1 Holding bolt in open position

- a. Remove magazine (see chapter „4.3 Magazine catch“ on page 14).
- b. Grab the charging handle and pull the bolt to the rear-most position and hold it there.



- c. Push the bolt catch upwards (available on left and right-weapon side).
- d. Allow the bolt to travel forward until stopped and held by the bolt catch.
- e. Push the charging handle to its foremost position.



4.7.2 Closing bolt

- a. Push the external bolt catch (available on left and right weapons side) until the bolt snaps into closed position.



4.8 Loading and unloading weapon

4.8.1 Loading weapon

- Fill the cartridges one by one into the magazine.
- Grab the weapon and engage safety (see chapter „4.2 Operating fire selector“ on page 13).
- Insert magazine.
- Pull the magazine slightly downward to verify it is locked in place.



- If the bolt is open, push the external bolt catch downwards.
- If the bolt is closed, vigorously pull back the charging handle to its rearmost position and allow the bolt to snap forward under its own power.



- Slightly pull the bolt rearward until you can spot the brass of the chambered cartridge in order to verify the weapon is loaded.



4.8.2 Unloading weapon during firing sessions

- Engage safety (see chapter „4.2 Operating fire selector“ on page 13).
- Remove the magazine (see chapter „4.3 Magazine catch“ on page 14).
- Pull the charging handle rearward and observe the chambered cartridge being ejected.
- Hold the bolt in open position using the bolt catch (see chapter „4.7.1 Holding bolt in open position“ on page 24) and make a visual check to see if the chamber is empty.
- Recover the loose cartridge.

4.8.3 Unloading weapon for storage

- Unload the weapon (see chapter „4.8.2 Unloading weapon during firing sessions“ on page 25).
- Close the bolt (see chapter „4.7.2 Closing bolt“ on page 24).
- Disengage safety (see chapter „4.2 Operating fire selector“ on page 13).
- Point the weapon into a safe direction and pull the trigger - the hammer strikes audibly.
- Engage safety (see chapter „4.2 Operating fire selector“ on page 13).
- Lock the Bolt to the rear (see chapter „4.7.1 Holding bolt in open position“ on page 24).
- Insert the “Safety-Flag”.
- Escort the bolt, with inserted safety flag, to the front.

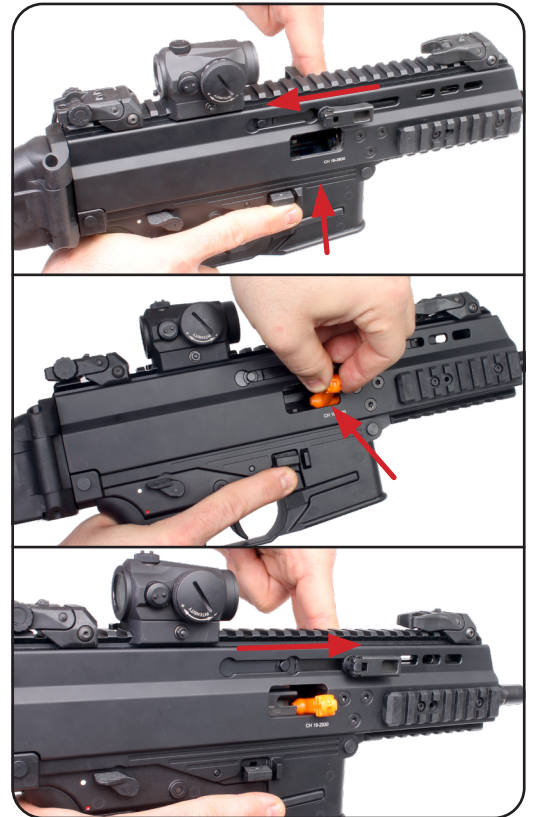

4.9 Firing the APC9 PRO

SAFETY ADVICE!	
	REFER «CHAPTER „1.1 SAFETY RULES“ ON PAGE 5»

- Engage iron sights (see chapter „4.6.1 Engaging iron sights“ on page 23).
- Load the Weapon (see chapter „4.8.1 Loading weapon“ on page 25).
- Apply a proper firing position.
- Disengage Safety (see chapter „4.2 Operating fire selector“ on page 13).
- Pull the trigger until the shot is released.



Advice!	
	Refer to «chapter „5.4 Functional check“ on page 35»

5. Maintenance procedures

Advice!	
	DO NOT OPERATE THE TRIGGER WHEN THE WEAPON IS DISASSEMBLED.



5.1 Disassembly

5.1.1 Disassembly of the weapon

- Clear the weapon (see chapter „4.1 Clearing weapon“ on page 13).
- Close the bolt (see chapter „4.7 Bolt catch“ on page 24).
- Press the front and rear take-down pin from left side to right side and pull it out from right side until the lower receiver comes loose.



- Separate the lower receiver from the weapon.



- Grasp the stock, press it down and pull it back out of the upper receiver.

Advice!	
	The telescopic stock must be in extracted position for pushing out the rear take-down pin.

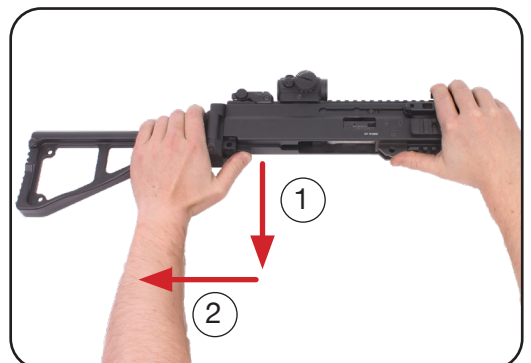

- f. Pull the charging handle backwards until the recoil spring can be grasped, then pull the recoil spring backwards out of the lower receiver.

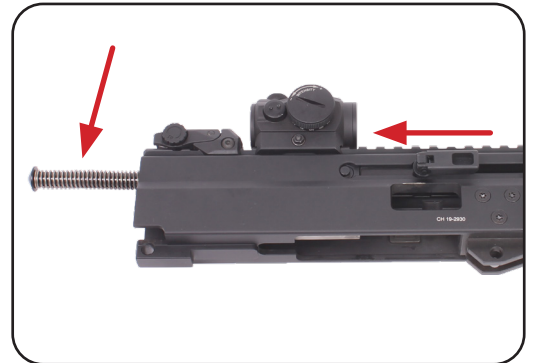

- g. Pull the charging handle further back until the bolt securing pin is congruent with the cutout in the upper receiver. Pull out the lock pin sideways and remove it from the upper receiver.



- h. Pull the bolt rearward out of the receiver and remove it.

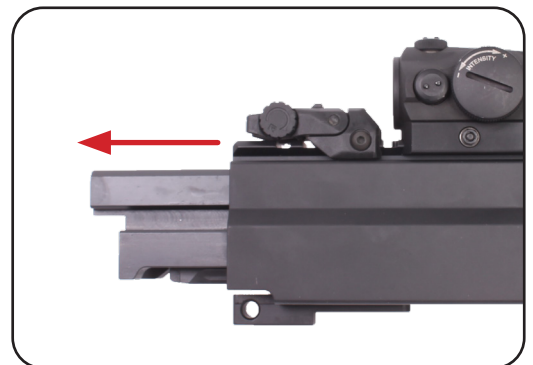

The weapon is now disassembled and ready for cleaning and inspections.



5.1.2 Disassembly upper receiver

- a. Pull the charging handle back until it is congruent with the cutout in the receiver.

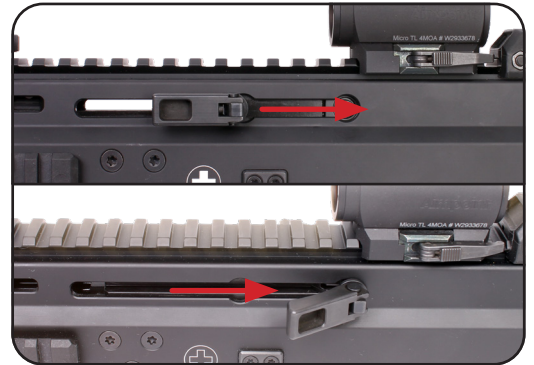

- b. Pull out both charging handles sideways and remove it from the handguard.

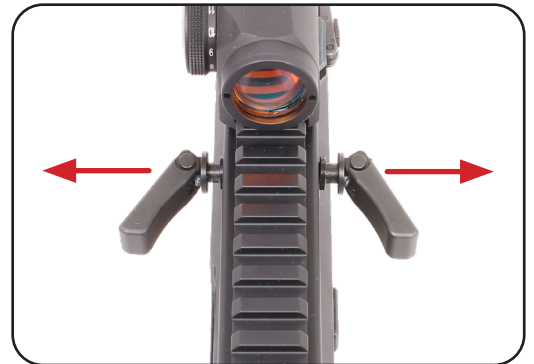

- c. Push the charging handle carrier out of the front of the upper receiver using the cleaning rod.



The upper receiver is now disassembled and ready for cleaning and inspections.

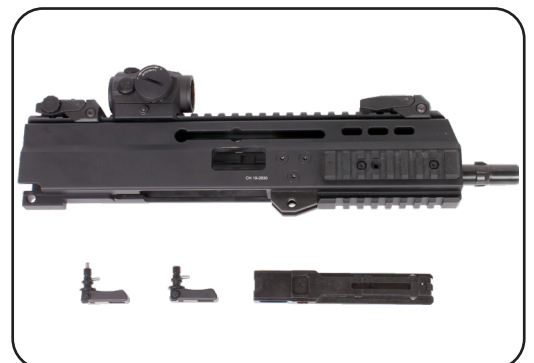

5.1.3 Disassembly upper receiver with suppressor

- a. Unscrew the suppressor.
- b. Loosen and remove the safety pin.
- c. Pull the hand guard forward away from the housing and remove it
- d. Pull the charging handle back until it is congruent with the cutout in the receiver.
- e. Pull out both charging handles sideways and remove it from the handguard.
- f. Push the charging handle carrier out of the front of the upper receiver using the cleaning rod.

The upper receiver is now disassembled and ready for cleaning and inspections.

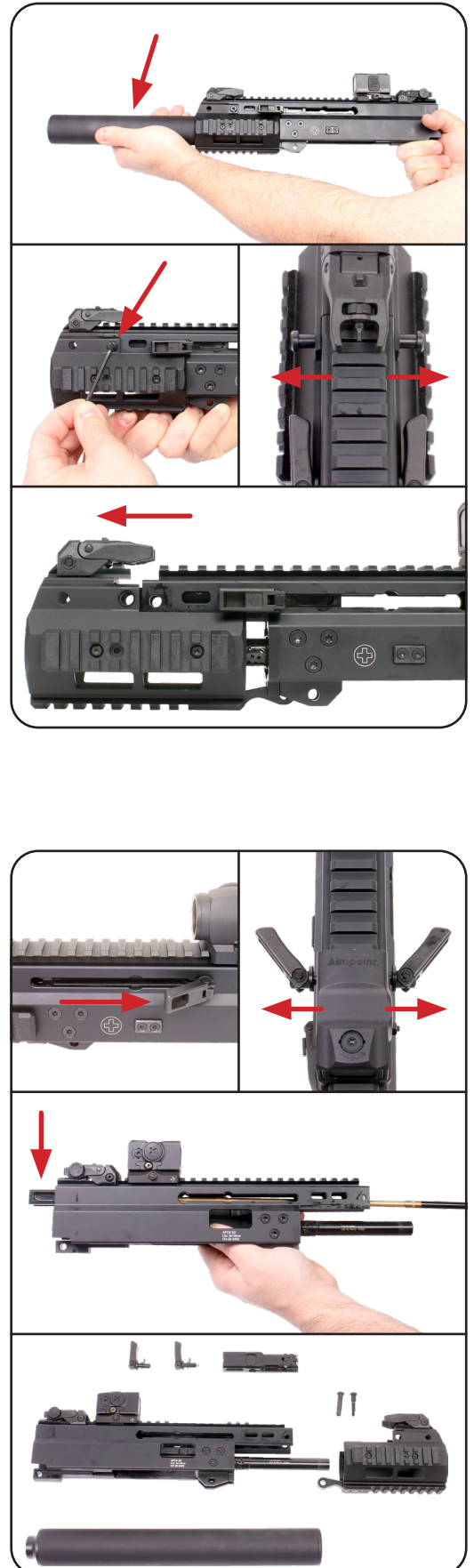

5.2 Cleaning and inspections

- Use a cleaning rod of suitable length with a copper brush to clean the barrel from the rear side.
- Use a small brush to remove particles captured in the cavities of lower and upper receiver.
- Use an oiled rag to wipe clean all accessible surfaces.
- Inspect all components and accessible parts for cracks, deformations or other signs of deterioration.
- Apply a slight film of oil to all accessible surfaces of steel parts



SAFETY ADVICE!



ADDRESS TO AN ARMORER IF THE SERVICE-ABILITY OF THE WEAPON SEEMS DOUBTFUL.

5.3 Reassembly

5.3.1 Reassembly of the weapon

- Assemble the upper receiver (see chapter „5.3.2 Assembly upper receiver“ on page 33) or (see chapter „5.3.3 Assembly upper receiver with suppressor“ on page 34).
- Insert the Bolt into the upper Receiver.
- Push in the bolt until it is aligned with the cutout in the receiver for installing the bolt securing pin.
- The bolt securing pin can be inserted on both sides of the receiver, depending on the users desire.

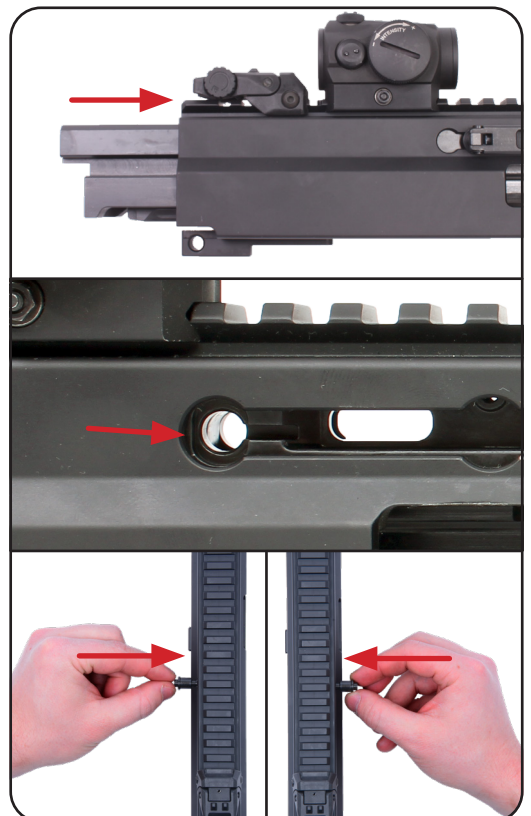

e. Insert the recoil spring into the housing.

Advice!	
	Check the alignment of the recoil spring! Insert the recoil spring into the lock with the curved end first.

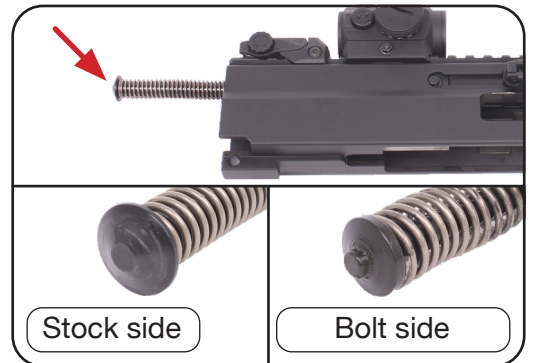

f. Insert the stock into the receiver and push it upwards.

Advice!	
	The telescopic stock must be in extracted position.

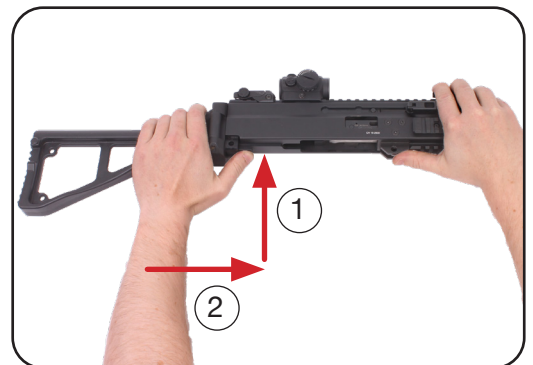

- g. Place the lower receiver on upper the receiver and push in the front and rear take-down pin from the right side.
- h. Execute a functional check (see chapter „5.4 Functional check“ on page 35).

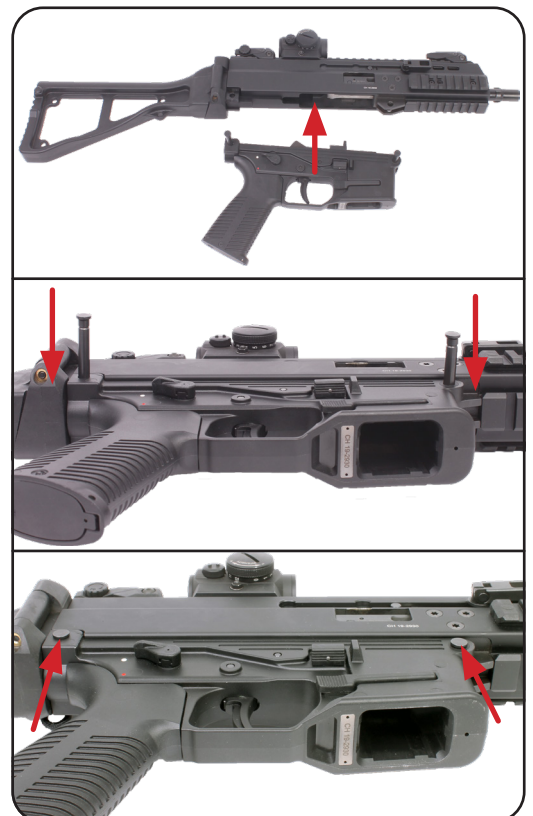

5.3.2 Assembly upper receiver

- a. Insert the charging handle carrier from the front into the handguard.

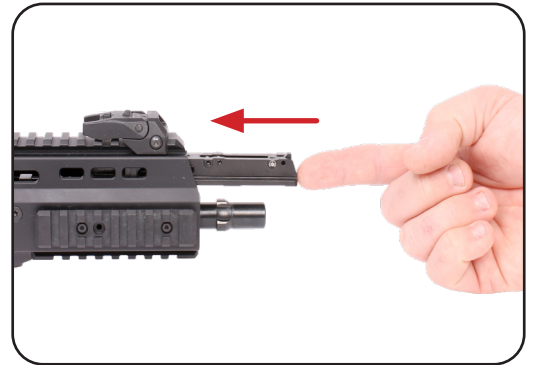

- b. Push in the charging handle carrier, by using the cleaning rod, until it is congruent with the cutout for installing the charging handle.

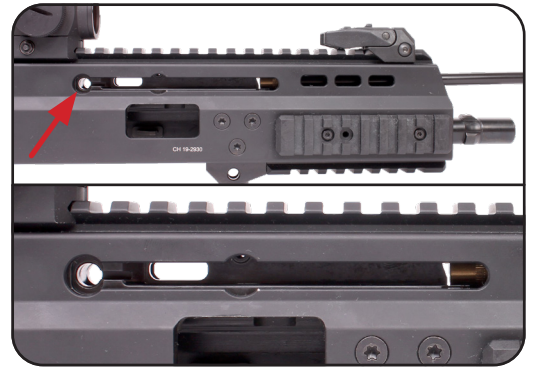

- c. Make sure to insert the charging handle in the correct orientation in order for the pin to slide into the recess in the charging handle carrier.

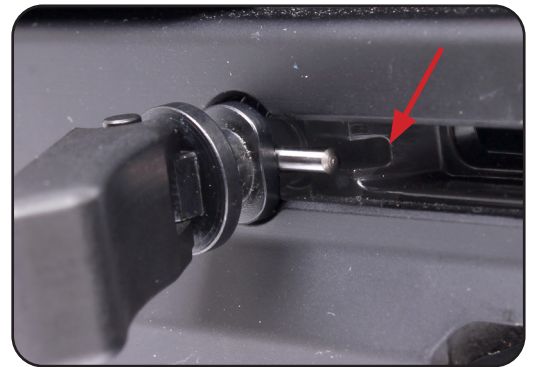

- d. Insert both charging handles on the side and press them together.

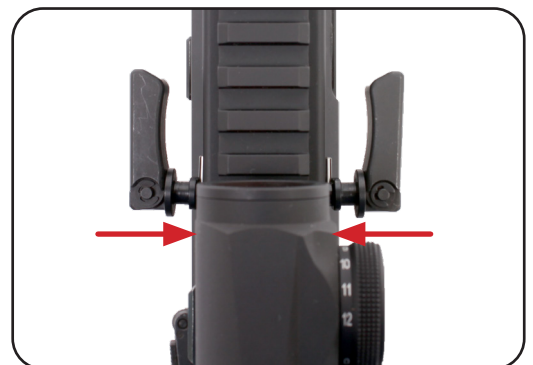

5.3.3 Assembly upper receiver with suppressor

- a. Insert the charging handle carrier from the front into the handguard.
- b. Push in the charging handle carrier, by using the cleaning rod, until it is congruent with the cutout for installing the charging handle.
- c. Make sure to insert the charging handle in the correct orientation in order for the pin to slide into the recess in the charging handle carrier.
- d. Insert both charging handles on the side and press them together.
- e. Slide the handguard on the upper receiver until the safety pin can be mounted.
- f. Mounting the safety pin.
- g. Mount the suppressor.

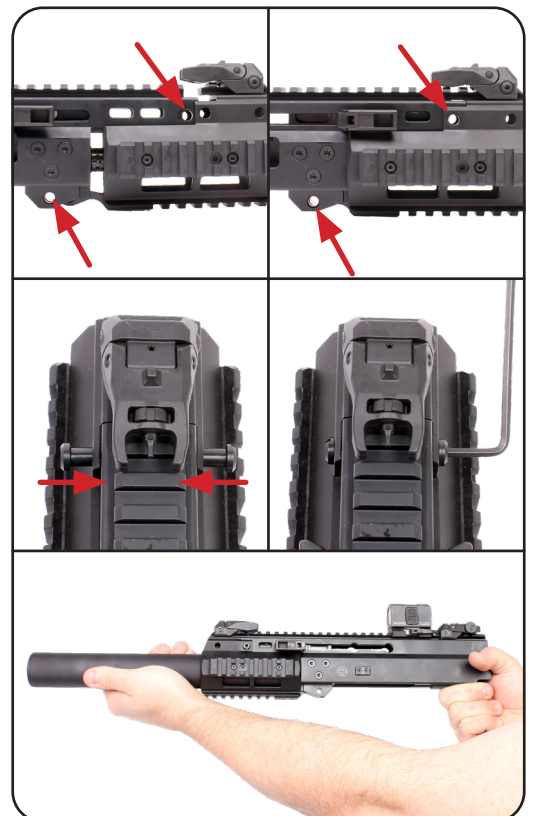

5.4 Functional check

- a. Clear weapon (see chapter „4.1 Clearing weapon“ on page 13).
- b. Push on right side bolt catch » bolt shall snap into closed position.
- c. Pull charging handle to its rearmost position and push bolt catch upward » bolt shall stay in open.
- d. Push on left side bolt catch » bolt shall snap into closed position.
- e. Engage safety and pull trigger » hammer shall not strike.
- f. Rotate right side fire selector to single fire position and back to safe position » shall snap audibly in both positions.
- g. Rotate left side fire selector to single fire position, pull trigger and hold » hammer shall strike audibly.
- h. Pull charging handle to the rearmost position and slide it to forward position. Release trigger and pull it again » hammer shall strike audibly.
- i. Engage safety, insert an empty magazine and pull downward » magazine retainer must hold securely.
- j. Pull charging handle to rearmost position and release » bolt shall stay open.
- k. Push left magazine retainer and pull magazine downward » magazine shall come loose.
- l. Reinsert empty magazine, push right magazine retainer and pull magazine downward » magazine shall come loose.
- m. Pull charging handle to the rearmost position and release » Bolt shall run to closed position. Repeat steps i to m with all available magazines.
- n. Engage sights » both shall audibly snap in open position and point straight upward.
- o. Close sights » both shall audibly snap in closed position.
- p. Check extracting and retracting and locking mechanisms of installed stock for proper function (see chapter „4.4 Stock / Adapter“ on page 15).
- q. Inspect installed accessories for function and tight mounting.

If any function fails, disassemble the weapon, check for defective parts, reassemble the weapon and check for correct reassembly. If the failure persists, refer to armorer.

5.5 Troubleshooting table

#	Observation	Immediate action	Page
1	Inconsistent impacts	Control correct position and tight sit of the iron sights. Present weapon at first opportunity to armorer for inspection.	23
2	Failure to feed	Hold the bolt open with the bolt catch, remove the magazine, if there are still cartridges in the upper receiver, remove them. Insert the magazine, close the bolt by pressing the bolt catch. If the malfunction is repeated, use another magazine. If the malfunction persists, have the gun checked by an armorer or the manufacturer.	25
3	Failure to eject	Pull charging handle to rearmost position and observe for ejected shell or cartridge. Inspect barrel to be clear. Load a fresh cartridge. Present weapon for inspection of extractor and ejector to an armorer at the first opportunity.	25
4	Failure to strike	Hold the bolt open with the bolt catch and remove eventual obstructions captured in the upper receiver. Load a fresh cartridge. If failure repeats, clean weapon or present it to an armorer.	13
5	Failure to ignite	Wait 30 seconds with the muzzle pointing to a safe direction. Then pull charging handle to rearmost position and observe for ejected cartridge. Collect cartridge for later analyses. Load a fresh cartridge. Present weapon and ejected cartridge to an armorer at the first opportunity	25

Advice!



Failure reports to the manufacturer must include the serial number of the weapon, the type of ammunitions, the history of the failure and the history of the attempted corrective actions. The report can be sent to B&T by E-Mail along with pictures

6. Accessories

6.1 Suppressors

Pos.	Item no.	Description
	SD-140250-TI	Suppressor PRINT-X RBS SQD XM™ with additional modul included
	SD-140974-TI	Suppressor PRINT-X QD™
	SD-140244-TI	Suppressor PRINT-X RBS SQD-XM Compact™

6.2 Stocks / Adapters

Picture	Art.-No.	Type	Description
	BT-361410 BT-361425	APC9/40/45 APC10	Foldable stock (standard)
	BT-361639 BT-361643	APC9/40/45 APC10	Fold- retractable stock PRO
	BT-20394 BT-200579	APC9/40/45 APC10	Telescopic stock
	BT-361412	APC9/40/45	Helmet stock
	BT-361114	APC9/40/45	Foldable stock (skeleton)

Picture	Art.-No.	Type	Description
	BT-361413	APC9/40/45	Fix stock
	BT-361415	APC9/40/45	M4 Adapter Foldable
	BT-361414 BT-361424	APC9/40/45 APC10	M4 Adapter
	BT-361555	APC9/40/45	NAR-Adapter

6.3 Magazines

Picture	Art.-No.	Type	Description
	BT-30183 BT-30298 BT-30296 BT-30209	APC9	Magazine 30 rounds Magazine 25 rounds Magazine 20 rounds Magazine 15 rounds
	BT-30531 BT-30376 BT-30528	APC45	Magazine 25 rounds Magazine 17 rounds Magazine 12 rounds
	GL-4429	SPC9	Magazine 33 rounds
	BT-231229 BT-30436	APC9 APC45	Magazine loader
	BT-300696	APC9	B&T bumper pad for magazine PRO
	BT-300698	APC9	B&T magazine upgrade kit with rubber bumper for old B&T magazines

Picture	Art.-No.	Type	Description
	BT-22379 BT-22380	APC9 APC45	Magazine clamp

6.4 Grips

Picture	Art.-No.	Description
	BT-231227-BK	Angled fore grip 45° Picatinny rail attachment
	BT-211564-BL	Unigrip QD short
	BT-21840	Unigrip QD

6.5 Flashlights

Picture	Art.-No.	Description
	BT-WMLX-B-W-L-GEN3	B&T Weapon Mounted Light GEN-3

6.6 Brass catcher

Picture	Art.-No.	Description
	BT-22362	Brasscatcher

6.7 Flash hider

Picture	Art.-No.	Description
	BT-400983	Flashhider Vortex QD

6.8 Sights

Pos.	Item no.	Description
	AP-200691	Aimpoint® sight ACRO P-2 3.5 MOA black

6.9 Maintenance

Picture	Art.-No.	Type	Description
	SC-99B/6		Cleaning rod extension
	SC-TR/P_9_M5 SC-TR/P_45_M5	APC9 APC45	Cleaning kit

7. Warranty statement

Warranty claims on behalf of the Client are to be explicitly declared as such. During the legal warranty period, B&T provides warranty cover solely for defects that arise as a result of faulty materials, construction errors or poor workmanship. If a warranty claim is justified, B&T will, at its own discretion, either repair or replace the defective good. Costs incurred in transporting the defective good to B&T are borne by the Client. Spare parts fitted and replaced become the property of B&T.

Inasmuch as is legally permitted, any other liability of B&T is excluded, in particular liability for damages arising either directly or indirectly from the delivered good itself, from its use or from its defects.

Merchandise is covered by the warranty provisions of the manufacturer. Parts that are naturally subject to wear and tear, damage arising from insufficient maintenance work, noncompliance with operating regulations and cases of force majeure are all excluded from warranty cover. Warranty claims lapse if the Client itself or third parties alter or repair the delivered good without the prior written consent of B&T. All product specifications are subject to change without prior notice. Published data are mean values and therefore not suitable acceptance criteria.

The manufacturer:

B&T AG - 3608 Thun - Switzerland

Phone +41 33 334 67 00

e-mail: info@bt-ag.com

Notes: